

1. 適用範圍 / SCOPE

此份規格書涵蓋 STE0603/0805/1206/2010/2512/3921/4527-series 金屬陶瓷電流感測電阻元件相關規格。

This specification covers STE0603/0805/1206/2010/2512/3921/4527-series, which are Metal Foil Current Sensing Resistor.

2. 產品型號/TYPE NUMBER

STE	0603/0805/1206/2010 /2512/3921/4527	M	xWx	Rxxx	*	*
	(1)	(2)	(3)	(4)	(5)	(6)

- (1) 產品系列號 / SERIES NUMBER : Ex.STE0805 =短電極/ short electrode ; 兩端子 / two terminal ; 有側導 / side electrode ; 尺寸 / size “0.08×0.05”
- (2) 產品材質 / Material : M = 錳銅合金 / MnCu alloy
- (3) 產品瓦特數 / Power Rating : Ex. W50=0.50 Watt ; 1W0=1.0 Watt
- (4) 產品阻值 / Nominal Resistance Value : Ex. 5mΩ →R005 ; 10mΩ →R010
- (5) 元件電阻偏差值 / Resistance Tolerance : Ex. D=±0.5% ; F=±1%
- (6) 產品碼/Product code:Ex. S→Special design ; blank→Original design

3. 產品尺寸 / PRODUCT DIMENSIONS



圖 1 / Fig.1

Unit(mm)

Part Number	W	L	T	A
STE0603MW50-series R005	0.90±0.20	1.70±0.20	0.65±0.15	0.50±0.20
STE0603MW50-series R006*S~R009*S	0.90±0.20	1.70±0.20	0.65±0.15	0.40±0.20
STE0603MW50-series R010~R100	0.90±0.20	1.70±0.20	0.65±0.15	0.40±0.20

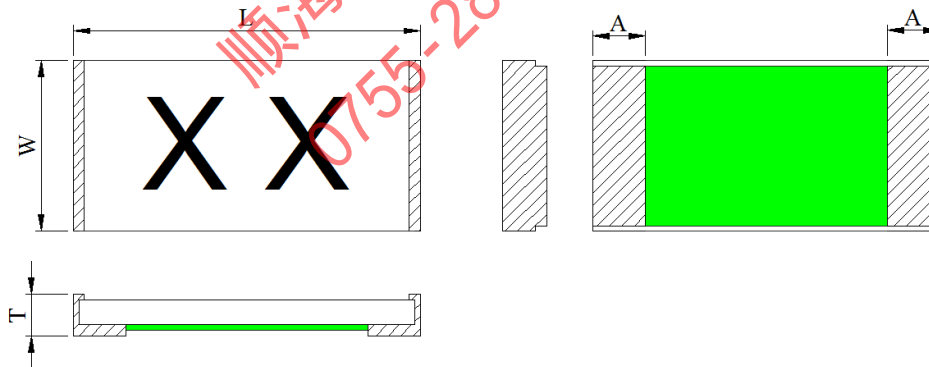
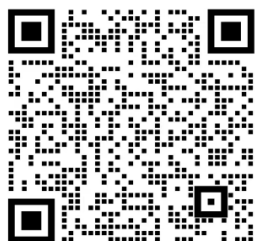

圖 2 / Fig.2

Unit(mm)

Part Number	W	L	T	A
STE0805MW75-series R003	1.35±0.20	2.10±0.20	0.65±0.20	0.65±0.20
STE0805MW75-series R004*S~R007*S	1.35±0.20	2.10±0.20	0.65±0.20	0.50±0.20
STE0805MW75-series R008~R500	1.35±0.20	2.10±0.20	0.65±0.20	0.50±0.20

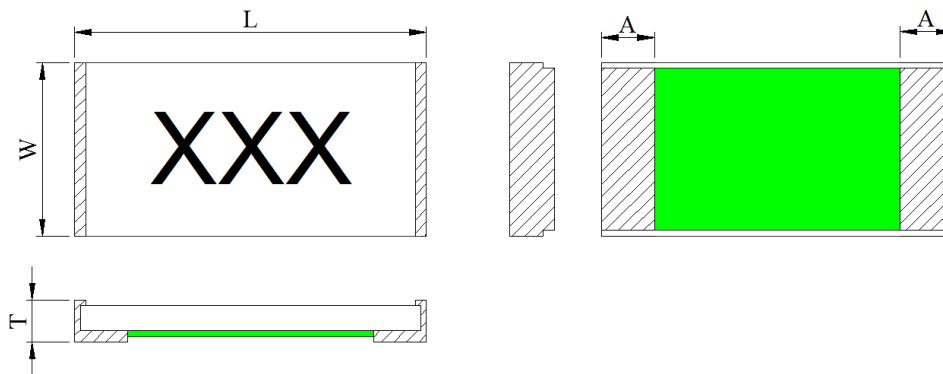

圖 3 / Fig.3

Unit(mm)

Part Number	W	L	T	A
STE1206M1W0-series R003	1.70±0.20	3.30±0.20	0.65±0.20	1.20±0.30
STE1206M1W0-series R004*S~R008*S	1.70±0.20	3.30±0.20	0.65±0.20	0.68±0.30
STE1206M1W0-series R009~R700	1.70±0.20	3.30±0.20	0.65±0.20	0.68±0.30

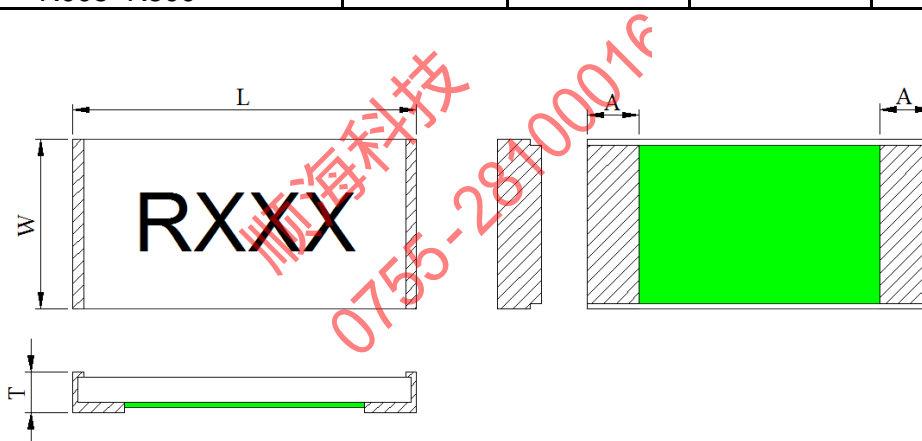
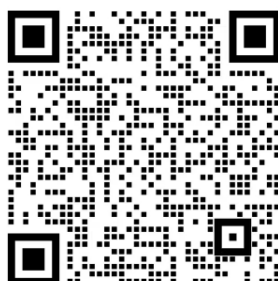

Part Number	W	L	T	A
STE2010M1W5-series R002~R003	2.60±0.20	5.10±0.20	0.65±0.20	2.10±0.30
STE2010M1W5-series R004*S~R009*S	2.60±0.20	5.10±0.20	0.65±0.20	0.70±0.30
STE2010M1W5-series R010~R700	2.60±0.20	5.10±0.20	0.65±0.20	0.70±0.30

Part Number	W	L	T	A
STE2512M2W0-series R002*S	3.20±0.30	6.40±0.30	0.75±0.20	1.65±0.30
STE2512M2W0-series R002	3.20±0.30	6.40±0.30	0.65±0.20	2.80±0.30
STE2512M2W0-series R003	3.20±0.30	6.40±0.30	0.65±0.20	2.60±0.30
STE2512M2W0-series R004*S~R009*S	3.20±0.30	6.40±0.30	0.65±0.20	1.05±0.30
STE2512M2W0-series R010~R700	3.20±0.30	6.40±0.30	0.65±0.20	1.05±0.30

Part Number	W	L	T	A
STE3921M3W0-series R002	5.10±0.30	11.10±0.30	0.65±0.20	4.90±0.30
STE3921M3W0-series R003	5.10±0.30	11.10±0.30	0.65±0.20	4.55±0.30
STE3921M3W0-series R004*S~R008*S	5.10±0.30	11.10±0.30	0.65±0.20	2.36±0.30
STE3921M3W0-series R009~R100	5.10±0.30	11.10±0.30	0.65±0.20	2.36±0.30

Part Number	W	L	T	A
STE4527M4W0-series R002	7.10±1.0	11.60±1.0	0.65±0.30	5.00±0.40
STE4527M4W0-series R003*S~R005*S	7.10±1.0	11.60±1.0	0.65±0.30	2.70±0.40
STE4527M4W0-series R006~R100	7.10±1.0	11.60±1.0	0.65±0.30	2.70±0.40

4. 產品結構及使用材料說明（參考圖 4） / STRUCTURE & MATERIAL (Ref to Fig.4)



圖 4 / Fig.4



- 4.1 基板 / Substrate(1) : 氧化鋁陶瓷基板 / Alumina Ceramic
- 4.2 粘著層 / Adhesion layer(2) : 環氧樹脂 / Epoxy
- 4.3 電阻本體 / Resistive element(3) : 銅合金 / Cu – alloy
- 4.4 端電極 / Terminal electrode(4) : 錫、鎳、銅 / Sn、Ni、Cu
- 4.5 保護防焊層 / Protective coating(5) : 防火級環氧樹脂,符合 UL- 94-V0 要求(綠色) /
Flame-retardant epoxy, meets UL- 94-V0 requirements(green)
- 4.6 文印防焊層 / Marking coating(6) : 防火級環氧樹脂,符合 UL- 94-V0 要求(黑色) /
Flame-retardant epoxy, meets UL- 94-V0 requirements (black)

5. 電氣特性 / ELECTRICAL CHARACTERISTICS

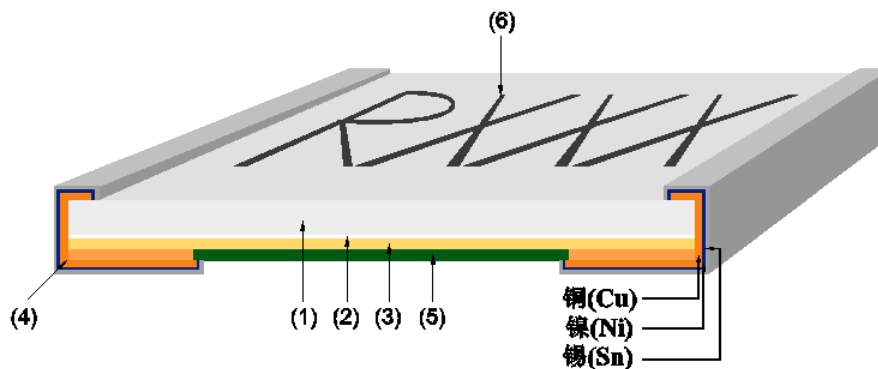
Part Number	Resistance Value (mΩ)	Power Rating (Watt)	Resistance Tolerance (%)	TCR (ppm/°C)
STE0603MW50-series R005~R100	5~9	0.5	±1%(F)	±75
	10~100	0.5	±0.5%(D) / ±1%(F)	±50

Part Number	Resistance Value (mΩ)	Power Rating (Watt)	Resistance Tolerance (%)	TCR (ppm/°C)
STE0805MW75-series R003~R500	3	0.75	±1%(F)	±75
	4~500	0.75	±0.5%(D) / ±1%(F)	±50

Part Number	Resistance Value (mΩ)	Power Rating (Watt)	Resistance Tolerance (%)	TCR (ppm/°C)
STE1206M1W0-series R003~R700	3	1.0	±1%(F)	±75
	4~700	1.0	±0.5%(D) / ±1%(F)	±50

Part Number	Resistance Value (mΩ)	Power Rating (Watt)	Resistance Tolerance (%)	TCR (ppm/°C)
STE2010M1W5-series R002~R700	2~9	1.5	±1%(F)	±100
	10~700	1.5	±0.5%(D) / ±1%(F)	±50

Part Number	Resistance Value (mΩ)	Power Rating (Watt)	Resistance Tolerance (%)	TCR (ppm/°C)
STE2512M2W0-series R002~R700	2~3	2.0	±1%(F)	±75
	4~700	2.0	±0.5%(D) / ±1%(F)	±50

Part Number	Resistance Value (mΩ)	Power Rating (Watt)	Resistance Tolerance (%)	TCR (ppm/°C)
STE3921M3W0-series R002~R100	2~9	3.0	±1%(F)	±100
	10~100	3.0	±0.5%(D) / ±1%(F)	±50

Part Number	Resistance Value (mΩ)	Power Rating (Watt)	Resistance Tolerance (%)	TCR (ppm/°C)
STE4527M4W0-series R002~R100	2~9	4.0	±1%(F)	±100
	10~100	4.0	±0.5%(D) / ±1%(F)	±50

規格外阻值可依客戶需求提供 / We can provide other resistance value per request

6. 產品特性及信賴性測試規範 / PRODUCT CHARACTERISTICS AND RELIABILITY TEST STANDARD

測試方法 Parameter	條件 Conditions	允收標準 Requirements
瞬間過載測試 / Short Time Over Load	$P = 2.5P_r$; $T = 25 \pm 2^\circ\text{C}$, $t = 5\text{sec}$.	$\pm(1.0\% + 0.5\text{m}\Omega)$ IEC60115-1 4.13
高溫測試 / High Temp. Exposure	$T = +155 \pm 2^\circ\text{C}$; $t = 1000\text{h}$	$\pm(1.0\% + 0.5\text{m}\Omega)$ IEC60115-1 4.25
低溫測試 / Low Temp. Storage	$T = -55 \pm 2^\circ\text{C}$; $t = 1000\text{h}$	$\pm(1.0\% + 0.5\text{m}\Omega)$ IEC60115-1 4.25
濕度負載壽命測試 / Moisture Load Life (60°C、95%RH)	$V_{\text{test}} = V_{\text{max}}$; $T = 60 \pm 2^\circ\text{C}$; $\text{RH} = 95\%$; $t = 90\text{min ON}$, 30min OFF , 1000h	$\pm(2.0\% + 0.5\text{m}\Omega)$ IEC60115-1 4.25
冷熱衝擊測試 / Thermal Shock	$[-55^\circ\text{C } 30\text{min.} \rightarrow \text{R.T. } 3\text{min.} \rightarrow +155^\circ\text{C } 30\text{min.}$ $\rightarrow \text{R.T. } 3\text{min.}]$, 100 個連續循環 / 100Cycles	$\pm(1.0\% + 0.5\text{m}\Omega)$ IEC60115-1 4.19
在 70°C 下負載壽命測試 / Load Life at 70°C	$V_{\text{test}} = V_{\text{max}}$; $T = 70 \pm 2^\circ\text{C}$; $t = 90\text{min ON}$, 30min OFF , 1000h	$\pm(2\% + 0.5\text{m}\Omega)$ IEC60115-1 4.25

可焊性測試 / Solderability	浸入錫爐 / Dip into solder at $T = 245 \pm 5^{\circ}\text{C}$, $t = 3 \pm 1 \text{ sec.}$	錫涵蓋面積/The covered area $>95\%$ IEC60115-1 4.17
抗焊熱性測試 / Resistance to Solder Heat	經熱風式迴焊爐 / Through Reflow Parts are subjected to 3 reflow cycles.	$\pm(1.0\%+0.5\text{m}\Omega)$ IEC60115-1 4.18
機械衝擊測試 / Mechanical Shock	加速度 $a = 100\text{G}$, 振幅時間 $t = 6\text{ms}$ $a = 100\text{G}$, $t = 6\text{ms}$	$\pm(1.0\%+0.5\text{m}\Omega)$ IEC60115-1 4.21
基板彎曲測試 / Substrate Bending	兩支撐點間距 / Span between fulcrums : 90mm ; 振幅 / Bend Width: 2mm ; 測試板/Test board: 玻璃纖維板/ Glass-Epoxy Board ; 厚度 / Thickness : 1.6mm	$\pm(1.0\%+0.5\text{m}\Omega)$ IEC60115-1 4.33

7. 環境特性 / ENVIRONMENTAL CHARACTERISTIC

7-1 操作溫度範圍: $-55^{\circ}\text{C} \sim 155^{\circ}\text{C}$ / Operating Temperature: $-55^{\circ}\text{C} \sim 155^{\circ}\text{C}$

額定功率溫度衰變曲線 / Typical Thermal Derating Curve

額定功率乃指於 70°C 以內可連續滿額功率使用的術語。

下圖為當操作溫度高於 70°C 時的可使用功率衰減曲線。

Power rating is based on continuous full load operation at rated ambient temperature of 70°C . For resistors operated at ambient temp. in excess of 70°C , the max. load shall be derated in accordance with the following curve.

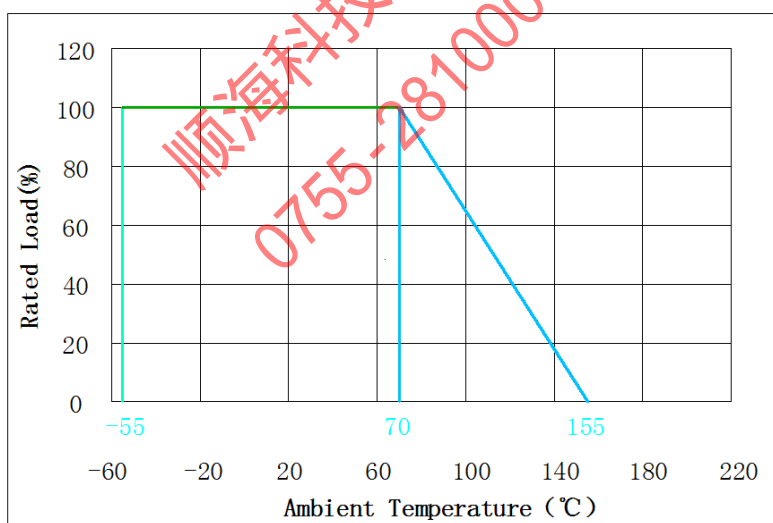

7-2 存儲條件 / STORAGE CONDITIONS

在溫度 $+10^{\circ}\text{C} \sim 40^{\circ}\text{C}$ 、相對濕度 $\leq 75\%$ 的密閉條件下可存放 2 年。 /

Under airtight in temperature $+10^{\circ}\text{C} \sim 40^{\circ}\text{C}$ 、relative humidity $\leq 75\%$ can store 2 years.

在溫度 $+10^{\circ}\text{C} \sim 60^{\circ}\text{C}$ 、相對濕度為 95% 的非露天下最多可存放 30 天。 /

Without dew in temperature $+10^{\circ}\text{C} \sim 60^{\circ}\text{C}$ 、relative humidity be 95% maximum value for 30 days.

8. 焊錫墊尺寸及焊接條件 / SOLDER PAD SIZE AND WELDING CONDITIONS

8-1 建議如下圖焊接方式焊接，並滿足所要求的尺寸。 / Propose that the following picture installation way is installed, and satisfied the required size.

Part Number	P	W	D	Loading
STE0603MW50-series R005	0.50mm	0.92mm	1.35mm	0.50w
STE0603MW50-series R006*S~R009*S	0.60mm	0.92mm	1.30mm	0.50w
STE0603MW50-series R010~R100	0.60mm	0.92mm	1.30mm	0.50w

Part Number	P	W	D	Loading
STE0805MW75-series R003	0.50mm	1.44mm	1.55mm	0.75w
STE0805MW75-series R004*S~R007*S	0.80mm	1.44mm	1.40mm	0.75w
STE0805MW75-series R008~R500	0.80mm	1.44mm	1.40mm	0.75w

Part Number	P	W	D	Loading
STE1206M1W0-series R003	0.60mm	1.84mm	2.10mm	1.0w
STE1206M1W0-series R004*S~R008*S	1.20mm	1.84mm	1.80mm	1.0w
STE1206M1W0-series R009~R700	1.20mm	1.84mm	1.80mm	1.0w

Part Number	P	W	D	Loading
STE2010M1W5-series R002~R003	0.70mm	2.88mm	3.65mm	1.5w
STE2010M1W5-series R004*S~R009*S	2.70mm	2.88mm	2.65mm	1.5w
STE2010M1W5-series R010~R700	2.70mm	2.88mm	2.65mm	1.5w

Part Number	P	W	D	Loading
STE2512M2W0-series R002*S	1.60mm	3.57mm	3.85mm	2.0w
STE2512M2W0-series R002	0.60mm	3.57mm	4.35mm	2.0w
STE2512M2W0-series R003	0.90mm	3.57mm	4.20mm	2.0w
STE2512M2W0-series R004*S~R009*S	3.10mm	3.57mm	3.10mm	2.0w
STE2512M2W0-series R010~R700	3.10mm	3.57mm	3.10mm	2.0w

Part Number	P	W	D	Loading
STE3921M3W0-series R002	1.10mm	5.75mm	6.45mm	3.0w
STE3921M3W0-series R003	1.70mm	5.75mm	6.15mm	3.0w
STE3921M3W0-series R004*S~R008*S	5.00mm	5.75mm	4.50mm	3.0w
STE3921M3W0-series R009~R100	5.00mm	5.75mm	4.50mm	3.0w

Part Number	P	W	D	Loading
STE4527M4W0-series R002	1.20mm	8.05mm	6.65mm	4.0w
STE4527M4W0-series R003*S~R005*S	5.20mm	8.05mm	4.65mm	4.0w
STE4527M4W0-series R006~R100	5.20mm	8.05mm	4.65mm	4.0w

loading : 適用於本公司建議焊墊設計並使用於限定穩定電流下 /
suit for specific pad layout and specific steady current

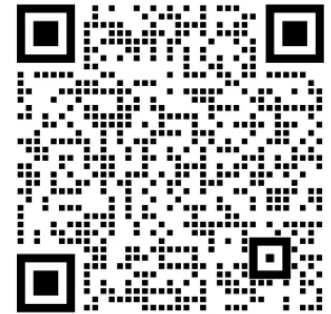
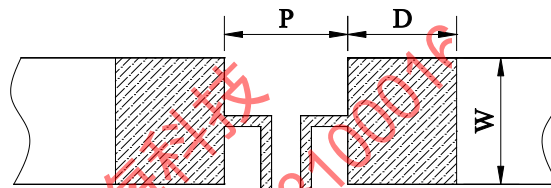

8-2 建議客戶焊接參數 / Recommended Customer Soldering Parameters

8-2-1 回流焊溫度曲線 / Solder reflow Temperature condition (圖 5 / Fig.5)



圖 5 / Fig.5

8-2-3 允許烙鐵焊接條件(熱風設備) / Rework temperature (hot air equipment) : 350°C,
3~5seconds

8-2-4 焊接方法建議 / Recommended reflow methods

焊接熱源方式可用紅外線, 熱蒸氣, 熱風. / IR, vapor phase oven, hot air oven
如果焊錫溫度超過允許最高溫度, 則產品本身會有功能損壞的疑慮. / If reflow temperatures
exceed the recommended profile, devices may not meet the performance requirements.

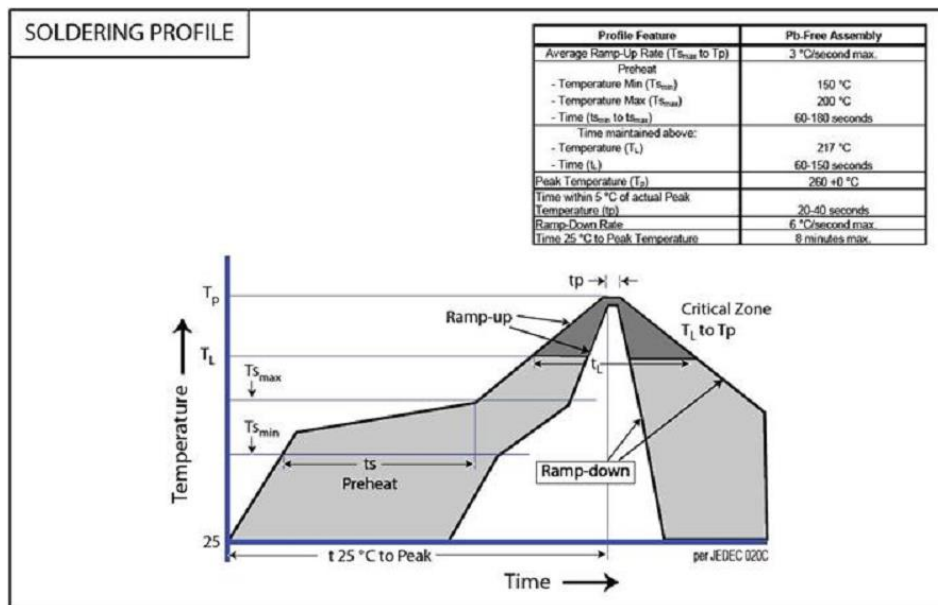
9. 批量生產後出貨測試項目 / Lot ACCEPTANCE TEST REQUIREMENTS

每一批生產均須作入庫檢驗, 每一批生產單量不可超過500Kpcs. /
Qualification shall consist of passing a program of following tests. Parts shall be pulled from
each lot and maximum lot quantity shall be within 500Kpcs.

9-1 外觀 / Visual

方法 / Procedure : 利用放大鏡進行檢查 / Visual
標準 / Acceptance Criteria : 不能有髒汙、不潔、文印錯誤、破損等 / No parts are outstandingly
stained

9-2 尺寸 / Dimensions

方法 / Procedure : 使用合適且經校正的尺規 / As appropriate, calipers, micrometers,
optical comparator, or approved gages
標準 / Acceptance Criteria : 尺寸均在規定標準範圍內 / No parts outside specific dimensions

9-3 單體元件電阻(Ro) / Resistance (Ro)

方法 / Procedure : 在 25°C 下利用四線量測技術量測之 / Resistance shall be measured with 25
°C in the 4-wire resistance test
標準 / Acceptance Criteria : 電阻值均在規定標準範圍內 / The resistance of the test device shall
be within the limits specified

9-4 電阻溫度係數 / TCR

方法 / Procedure : 利用四線法量測出元件分別在 25°C 及125°C 下的電阻值, 並將其帶入下面公
式中即可得出 TCR值 / Getting the sampling device resistance values measured in 25°C and
125°C and put them in to the following equation to calculate the TCR
標準 / Acceptance Criteria : 溫度係數值均在規定標準範圍內 / All parts must within the specific
$$TCR = (R_b - R_a) / R_a \times 1 / (T_b - T_a) \times 10^6$$

9-5 絕緣電阻 / Insulation resistance (Ri)

方法 / Procedure : 利用絕緣測試儀量測 / Resistance between protective layer and resistive shall
be measured by high ohm meter
標準 / Acceptance Criteria : 防焊層與電阻本體絕緣電阻至少高於100MΩ / The resistance of the
test device shall over 100MΩ

10. 包裝訊息 / PACKAGING INFORMATION

10-1 包裝數量、重量 / QUANTITY & WEIGHT

型號 / Type Number	數量 / Quantity (pcs)	重量 / Weight (g)
STE0603MW50-series	5,000	130±30
STE0805MW75-series	5,000	150±30
STE1206M1W0-series	5,000	160±40
STE2010M1W5-series	4,000	210±40
STE2512M2W0-series	4,000	270±50
STE3921M3W0-series	2,000	510±60
STE4527M4W0-series	1,000	380±60

10-2 捲輪規格 / Reel & Tape specifications

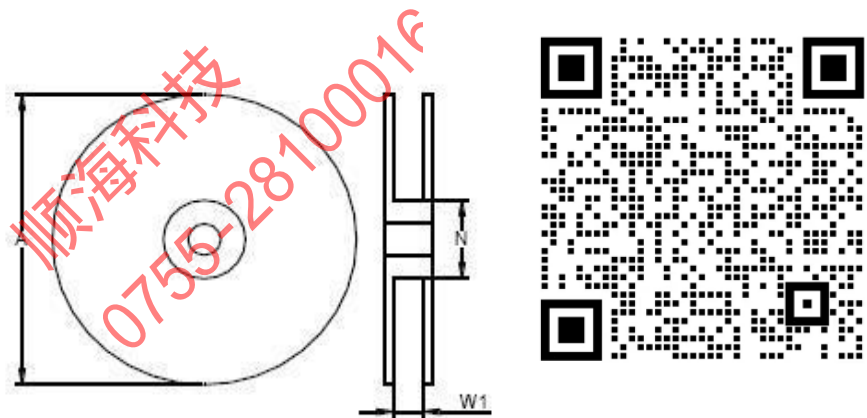

型號 / Type Number	A±5 (mm)	N±2 (mm)	W1±1 (mm)
STE0603MW50-series	178	60	9.0
STE0805MW75-series	178	60	9.0
STE1206M1W0-series	178	60	9.0
STE2010M1W5-series	178	60	13
STE2512M2W0-series	178	60	13
STE3921M3W0-series	178	60	24.5
STE4527M4W0-series	178	60	24.5

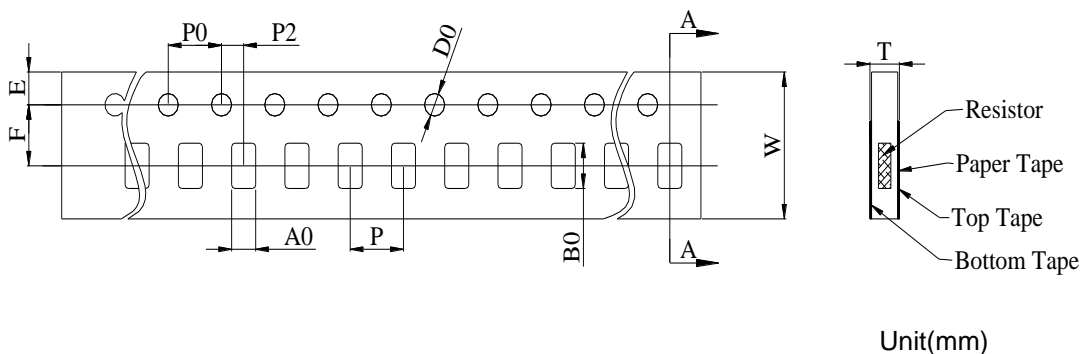

STE0603MW50-series							
W	8.00 ± 0.30	P0	4.00 ± 0.10	P	4.00 ± 0.10	P2	2.00 ± 0.10
A0	1.10 ± 0.10	B0	1.90 ± 0.10	D0	1.50 ± 0.10	F	3.50 ± 0.10
E	1.75 ± 0.10	T	0.75 ± 0.10	/	/	/	/

STE0805MW75-series							
W	8.00 ± 0.30	P0	4.00 ± 0.10	P	4.00 ± 0.10	P2	2.00 ± 0.10
A0	1.55 ± 0.10	B0	2.30 ± 0.10	D0	1.50 ± 0.10	F	3.50 ± 0.10
E	1.75 ± 0.10	T	0.87 ± 0.10	/	/	/	/

STE1206M1W0-series							
W	8.00 ± 0.30	P0	4.00 ± 0.10	P	4.00 ± 0.10	P2	2.00 ± 0.10
A0	2.05 ± 0.20	B0	3.65 ± 0.20	D0	1.50 ± 0.10	F	3.50 ± 0.10
E	1.75 ± 0.10	T	0.87 ± 0.10	/	/	/	/

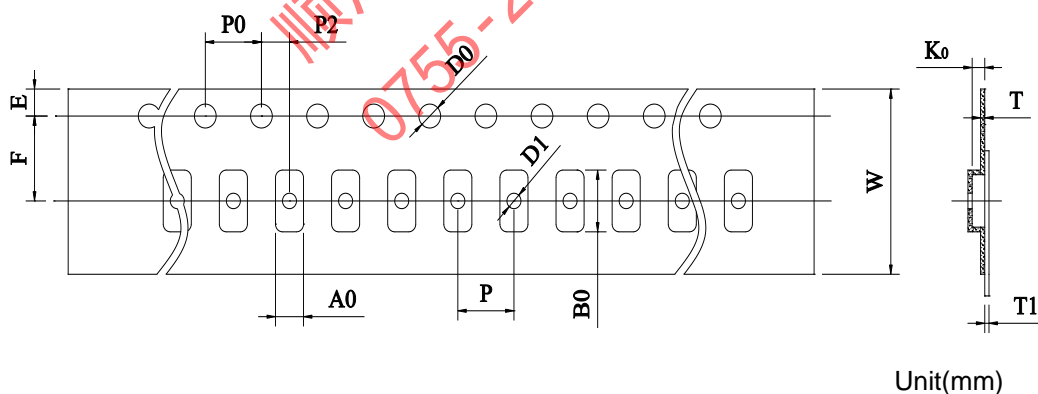

STE2010M1W5-series							
W	12.00 ± 0.30	P0	4.00 ± 0.10	P	4.00 ± 0.10	P2	2.00 ± 0.10
A0	2.85 ± 0.20	B0	5.45 ± 0.20	D0	1.50 ± 0.10	F	5.50 ± 0.10
E	1.75 ± 0.10	T	0.25 ± 0.10	T1	Max. 0.1	K0	0.80 ± 0.20

STE2512M2W0-series							
W	12.00 ± 0.30	P0	4.00 ± 0.10	P	4.00 ± 0.10	P2	2.00 ± 0.10
A0	3.40 ± 0.20	B0	6.75 ± 0.20	D0	1.50 ± 0.10	F	5.50 ± 0.10
E	1.75 ± 0.10	T	0.25 ± 0.10	T1	Max. 0.1	K0	1.00 ± 0.20

STE3921M3W0-series							
W	24.00 ± 0.30	P0	4.00 ± 0.10	P	8.00 ± 0.10	P2	2.00 ± 0.10
A0	5.50 ± 0.20	B0	11.50 ± 0.20	D0	1.50 ± 0.10	F	11.50 ± 0.10
E	1.75 ± 0.10	T	0.30 ± 0.10	T1	Max. 0.1	K0	0.90 ± 0.20

STE4527M4W0-series							
W	24.00 ± 0.30	P0	4.00 ± 0.10	P	12.00 ± 0.10	P2	2.00 ± 0.10
A0	7.50 ± 0.20	B0	12.00 ± 0.20	D0	1.50 ± 0.10	F	11.50 ± 0.10
E	1.75 ± 0.10	T	0.30 ± 0.10	T1	Max. 0.1	K0	0.90 ± 0.20

10-3 密封膠膜剝離強度要求 / Peeling Strength of Seal Tape

F = 剝離強度 : 0.1 – 1.0N (10 - 100gf)

F = Peeling Strength: 0.1 – 1.0N (10 - 100gf)

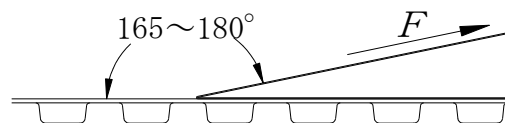

11. 其他 / OTHERS

11-1 如果在使用中有超出本規格書的要求，必須經由雙方協商確認。 / In the event that an impropriety is found beyond this specification , it shall be fixed by mutual agreement between the parties.

11-2 如果本規格書有不適當的情況，必須通過雙方協商並由本公司修改。 / In the event that an impropriety is found in this specification , Juneway Electronic Technology Co., Ltd. shall amend it by mutual agreement between the parties.

