

## 无铅厚膜贴片电阻承认书-PF 系列

### Approval Specification for Lead Free Thick Film Chip Resistors - Type **PF**

#### 1. 范围 (scope) :

适用于本公司所生产的无铅、无卤之无铅厚膜贴片电阻 PF 系列

This specification applies to lead free thick film chip resistors which meet requirements of Pb free and halogen free.



#### 2. 产品料号 (part number) :

0603 1/10W 5% 100 Ω

PF0603JA0101G





| <u>PF</u>   | <u>0603</u>  | <u>J</u>   | <u>A</u>  | <u>0101</u>  | <u>G</u>   |
|---|--|--|---|--|--|
| ↓   | ↓  | ↓  | ↓   | ↓  | ↓  |
| 类型(Type)<br>PF: 无铅厚膜<br>贴片电阻(Lead<br>free thick film<br>chip resistors) | 尺寸(Size)<br>0201<br>0402<br>0603<br>0805<br>1206<br>1210<br>2010<br>2512 | 公差<br>Tolerance<br>B=±0.1%<br>D=±0.5%<br>F=±1%<br>G=±2%<br>J=±5%<br>K=±10% | 额定功率<br>Rated Power<br>1= 1W<br>2= 3/4W<br>3= 1/2W<br>4= 1/4W<br>8= 1/8W<br>A= 1/10W<br>F= 1/16W<br>H=1/20W | 阻值<br>Resistance value<br>±1% , ±0.5% :<br>49R9=49.9 Ω<br>1002=10K Ω<br>±2% , ±5% :<br>06R8=6.8 Ω<br>0564=560K Ω | 包装代码<br>Packing Code<br>G= reel (卷装)<br>V= bulk (散料)<br>S= Double Standard<br>Quantity (两倍卷<br>盘标准包装量) |



## 无铅厚膜贴片电阻承认书-PF 系列

### Approval Specification for Lead Free Thick Film Chip Resistors - Type **PF**

#### 3. 电阻本体字码标示(Marking on the Resistor's Body):

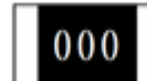
|   |  |   |
|---|--|---|
| ※ 0201 及 0402 因本体太小，本体上无字码标示<br>For 0201 and 0402 size, no marking on the body due to the small size of the resistor  |    | $472=47 \times 10^2=4.7K\Omega$                               |
| ※ 公差±5%的产品，以三字码标示，前两位表示阻值的有效数字，最后一位表示 10 的乘幂<br>±5% tolerance product: the marking is 3 digits, the first 2 digits are significant figures of resistance value and the 3rd one denotes the power number of 10, ( $10^x$ )             |    | 10Ω 以下标示: $5R6=5.6\Omega$<br>Below 10Ω: $5R6=5.6\Omega$       |
| ※ ±0.5%, ±1%的产品，以四字码标示，前三位表示阻值的有效数字，最后一位表示 10 的乘幂<br>±0.5%, ±1% tolerance product: the marking is 4 digits, the first 3 digits are significant figures of resistance value and the 4th one denotes the power number of 10, ( $10^x$ ) |    | $4992=499 \times 10^2=49.9K\Omega$                            |
| ※ 0603 ±1% E96 系列的标准阻值，因电阻本体太小，采用三位代码标示。<br>Standard E96 series values of 0603 ±1%: due to the small size of the resistor's body, use 3digits code to indicate the resistance value.  |  | 100Ω 以下标示: $6R81=6.81\Omega$<br>Below 100Ω: $6R81=6.81\Omega$ |
| ※ 0 欧姆产品，采用 000 三位代码标示。<br>0Ω Products, use 000 3digits code to indicate the resistance value.  |  | $000=0\Omega$   |



## 无铅厚膜贴片电阻承认书-PF 系列

### Approval Specification for Lead Free Thick Film Chip Resistors - Type **PF**

0603 ±1% E96 系列的标准阻值代码(Standard E96 Series Resistance Value Code for 0603 ±1% Marking)

| 代码 Code | 阻值 Value | 代码 Code | 阻值 Value | 代码 Code | 阻值 Value | 代码 Code | 阻值 Value | 代码 Code | 阻值 Value | 代码 Code | 阻值 Value |
|---------|----------|---------|----------|---------|----------|---------|----------|---------|----------|---------|----------|
| 01      | 100      | 17      | 147      | 33      | 215      | 49      | 316      | 65      | 464      | 81      | 681      |
| 02      | 102      | 18      | 150      | 34      | 221      | 50      | 324      | 66      | 475      | 82      | 698      |
| 03      | 105      | 19      | 154      | 35      | 226      | 51      | 332      | 67      | 487      | 83      | 715      |
| 04      | 107      | 20      | 158      | 36      | 232      | 52      | 340      | 68      | 499      | 84      | 732      |
| 05      | 110      | 21      | 162      | 37      | 237      | 53      | 348      | 69      | 511      | 85      | 750      |
| 06      | 113      | 22      | 165      | 38      | 243      | 54      | 357      | 70      | 523      | 86      | 768      |
| 07      | 115      | 23      | 169      | 39      | 249      | 55      | 365      | 71      | 536      | 87      | 787      |
| 08      | 118      | 24      | 174      | 40      | 255      | 56      | 374      | 72      | 549      | 88      | 806      |
| 09      | 121      | 25      | 178      | 41      | 261      | 57      | 383      | 73      | 562      | 89      | 825      |
| 10      | 124      | 26      | 182      | 42      | 267      | 58      | 392      | 74      | 576      | 90      | 845      |
| 11      | 127      | 27      | 187      | 43      | 274      | 59      | 402      | 75      | 590      | 91      | 866      |
| 12      | 130      | 28      | 191      | 44      | 280      | 60      | 412      | 76      | 604      | 92      | 887      |
| 13      | 133      | 29      | 196      | 45      | 287      | 61      | 422      | 77      | 619      | 93      | 909      |
| 14      | 137      | 30      | 200      | 46      | 294      | 62      | 432      | 78      | 634      | 94      | 931      |
| 15      | 140      | 31      | 205      | 47      | 301      | 63      | 442      | 79      | 649      | 95      | 953      |
| 16      | 143      | 32      | 210      | 48      | 309      | 64      | 453      | 80      | 665      | 96      | 976      |

0603 ±1% E96 系列的指数代码(Multiplier Code for 0603 ±1% Marking)

| 代码 Code       | Y                | X                | A               | B               | C               | D               | E               | F               |
|---------------|------------------|------------------|-----------------|-----------------|-----------------|-----------------|-----------------|-----------------|
| 指数 Multiplier | 10 <sup>-2</sup> | 10 <sup>-1</sup> | 10 <sup>0</sup> | 10 <sup>1</sup> | 10 <sup>2</sup> | 10 <sup>3</sup> | 10 <sup>4</sup> | 10 <sup>5</sup> |

阻值标示如下(So the resistance value are marked as the following examples)



$$10D=124 \times 10^3=124K\Omega$$



$$38Y=243 \times 10^{-2}=2.43\Omega$$

0603 ±1%的产品，在标准 E24 系列中，但不属于 E96 系列，标示与 5%的字码相同，但是在字码下加一条线  
 Standard E24 and not belong to E96 series values of 0603 ±1%, the marking is the same as 5% tolerance but marking as underline



$$33\underline{1}=33 \times 10^1=330\Omega$$



$$56\underline{0}=56 \times 10^0=56\Omega$$

**Approval Specification for Lead Free Thick Film Chip Resistors - Type PF**

## 4. 尺寸 (dimension) :

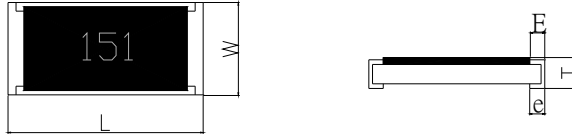
| 尺寸<br>dimension |  |           |           |           |           |
|-----------------|---|-----------|-----------|-----------|-----------|
|                 | 单位 (unit) : mm  |           |           |           |           |
| 型别 (Type)       | L   | W         | T         | E         | e         |
| PF0201          | 0.60±0.03   | 0.30±0.03 | 0.23±0.03 | 0.10±0.05 | 0.15±0.05 |
| PF0402          | 1.00±0.05   | 0.50±0.05 | 0.30±0.05 | 0.15±0.10 | 0.20±0.10 |
| PF0603          | 1.60±0.10   | 0.80±0.10 | 0.45±0.10 | 0.25±0.20 | 0.30±0.20 |
| PF0805          | 2.00±0.15   | 1.25±0.15 | 0.50±0.10 | 0.35±0.20 | 0.40±0.20 |
| PF1206          | 3.10±0.15   | 1.60±0.15 | 0.55±0.10 | 0.45±0.25 | 0.40±0.25 |
| PF1210          | 3.10±0.15   | 2.50±0.15 | 0.55±0.15 | 0.35±0.25 | 0.60±0.25 |
| PF2010          | 5.00±0.20   | 2.50±0.20 | 0.55±0.15 | 0.65±0.25 | 0.50±0.25 |
| PF2512          | 6.25±0.20   | 3.10±0.20 | 0.55±0.15 | 0.85±0.25 | 0.95±0.25 |

## 5. 功率衰减曲线 ( Derating Curve) :

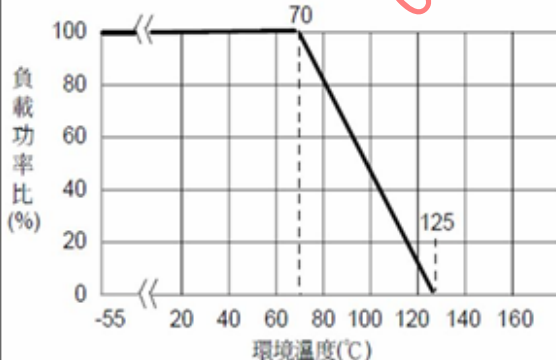
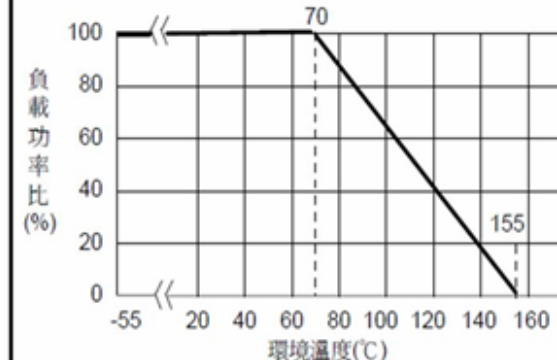
| 使用<br>溫度範圍          | -55°C ~ +125°C (0201)   | -55°C ~ +155°C (其他)  |
|---------------------|---|--|
| 說明                  | 周圍溫度若超過70°C至125°C之間，功率可照下圖曲線予以修定之。  | 周圍溫度若超過70°C至155°C之間，功率可照下圖曲線予以修定之。   |
| 功率<br>衰減<br>曲線<br>圖 |  |  |

工作温度范围 (Operating Temperature Range) : -55°C~+125°C (0201 规格);  
 -55°C~+155°C (其他规格)

储存条件 (storage condition) : 5~30°C, 30~75%RH.

**Approval Specification for Lead Free Thick Film Chip Resistors - Type PF**

## 6.电阻结构 (Construction) :

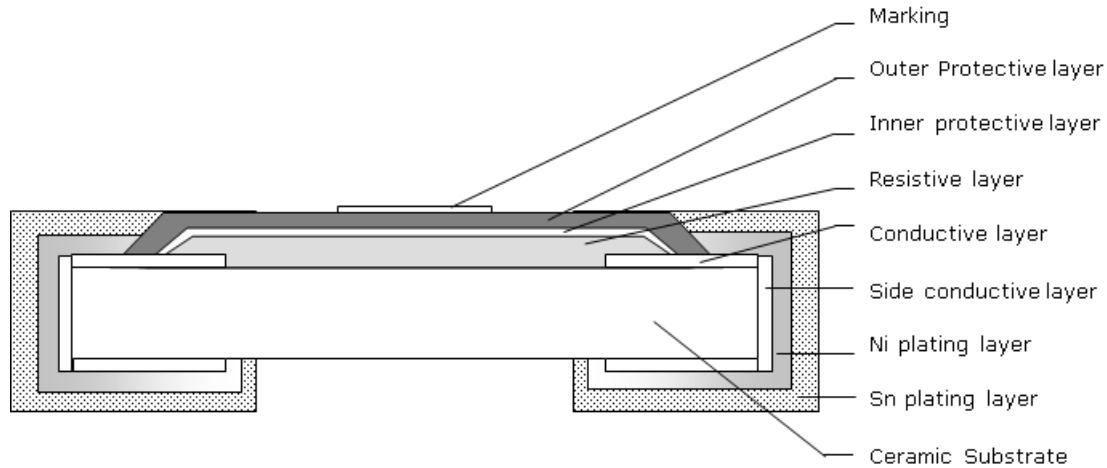

| No. | 结构<br>construction             | 主要材料<br>Major material                  |
|-----|--------------------------------|---|
| 1   | 陶瓷基板<br>Ceramic substrate      | 三氧化二铝<br>Al <sub>2</sub> O <sub>3</sub> |
| 2   | 银电极<br>Conductive layer        | 银<br>Ag                                 |
| 3   | 侧电极<br>Side conductive layer   | 镍铬合金<br>NiCr                            |
| 4   | 阻体层<br>Resistive layer         | 氧化钌+玻璃<br>RuO <sub>2</sub> + glass      |
| 5   | 内保护层<br>Inner protective layer | 玻璃<br>Glass                             |
| 6   | 外保护层<br>Outer Protective layer | 环氧树脂<br>Epoxy                           |
| 7   | 文字<br>Marking                  | 环氧树脂<br>Epoxy                           |
| 8   | 镍电极<br>Ni plating layer        | 镍<br>Ni                                 |
| 9   | 锡电极<br>Sn plating layer        | 雾锡<br>Matte Tin                         |



## 无铅厚膜贴片电阻承认书-PF 系列

### Approval Specification for Lead Free Thick Film Chip Resistors - Type **PF**

#### 7. 阻值范围 (resistance range) :

| 型别 Type | 阻值范围<br>Resistance Range |         |         |         |         |
|---------|--------------------------|---------|---------|---------|---------|
|         | 0.1%                     | 0.5%    | 1%      | 2%      | 5%      |
| PF0201  | 100Ω~1MΩ                 | 10Ω~1MΩ | 1Ω~10MΩ | 1Ω~10MΩ | 1Ω~10MΩ |
| PF0402  | 100Ω~1MΩ                 | 10Ω~1MΩ | 1Ω~22MΩ | 1Ω~22MΩ | 1Ω~22MΩ |
| PF0603  | 100Ω~1MΩ                 | 10Ω~1MΩ | 1Ω~22MΩ | 1Ω~22MΩ | 1Ω~22MΩ |
| PF0805  | 100Ω~1MΩ                 | 10Ω~1MΩ | 1Ω~22MΩ | 1Ω~22MΩ | 1Ω~22MΩ |
| PF1206  | 100Ω~1MΩ                 | 10Ω~1MΩ | 1Ω~22MΩ | 1Ω~22MΩ | 1Ω~22MΩ |
| PF1210  | 100Ω~1MΩ                 | 10Ω~1MΩ | 1Ω~22MΩ | 1Ω~22MΩ | 1Ω~22MΩ |
| PF2010  | 100Ω~1MΩ                 | 10Ω~1MΩ | 1Ω~22MΩ | 1Ω~22MΩ | 1Ω~22MΩ |
| PF2512  | 100Ω~1MΩ                 | 10Ω~1MΩ | 1Ω~22MΩ | 1Ω~22MΩ | 1Ω~22MΩ |

#### 8. 电气特性 (electrical characteristics) :

| 型别 Type                                 | PF0201 | PF0402 | PF0603 | PF0805 | PF1206 | PF1210 | PF2010 | PF2512 |
|---|--------|--------|--------|--------|--------|--------|--------|--------|
| 额定功率<br>Rated power                     | 1/20W  | 1/16W  | 1/10W  | 1/8W   | 1/4W   | 1/2W   | 3/4W   | 1W     |
| 最大工作电压<br>Max Working Voltage           | 25V    | 50V    | 75V    | 150V   | 200V   | 200V   | 200V   | 200V   |
| 最大过负荷电压<br>Max Overload Voltage         | 50V    | 100V   | 150V   | 300V   | 400V   | 500V   | 500V   | 500V   |
| 绝缘耐压<br>Dielectric Withstanding Voltage | 75V    | 150V   | 220V   | 430V   | 570V   | 710V   | 710V   | 710V   |
| 零欧姆阻值<br>Resistance Value of Jumper     | <50mΩ  | <50mΩ  | <50mΩ  | <50mΩ  | <50mΩ  | <50mΩ  | <50mΩ  | <50mΩ  |
| 零欧姆额定电流<br>Rated Current of Jumper      | 0.5A   | 1.0A   | 1.0A   | 2.0A   | 2.0A   | 2.0A   | 2.0A   | 2.0A   |
| 零欧姆电阻最大电流<br>Max Current of Jumper      | 1.0A   | 2.0A   | 2.0A   | 5.0A   | 10.0A  | 10.0A  | 10.0A  | 10.0A  |

#### 备注 (remark) :

※ 额定电压计算公式 (The rated voltage is calculated by the following formula) :

$$E = \sqrt{RP}$$

E : 额定电压 (Rated Voltage) (V)

P : 额定功率 (Rated Power) (W)

R : 电阻阻值 (Resistance) (ohm)

※ 如果计算出的电压超过此型别的最大工作电压, 则此型别的最大工作电压为此电阻的额定电压。

In case the value calculated by the formula exceed the maximum working voltage as above table 8, the maximum working voltage shall be regarded as rated voltage.



## 无铅厚膜贴片电阻承认书-PF 系列

### Approval Specification for Lead Free Thick Film Chip Resistors - Type **PF**

#### 9.性能信赖性测试 (Performance Reliability Test Methods)

| 内容<br>Item                                    | 测试方法<br>Test Methods | 测试条件<br>Test Conditions   | 规格<br>Specification   |
|---|----------------------|---|---|
| 温度系数<br>Temperature<br>Coefficient            | JIS C 5201 4.8       | $TCR = (R - R_0) / (t - t_0) R_0 \times 10^6$ (ppm)<br>R <sub>0</sub> 电阻在室温下的阻值(resistance at room temperature)<br>R 电阻在 125°C 或 -55°C 下的阻值(resistance at 125°C or -55°C)<br>t <sub>0</sub> 室温(room temperature)<br>t 测试温度 (test temperature 125°C or -55°C)                                    | 0201 规格：<br>1Ω ≤ R ≤ 10Ω：<br>-100~+300PPM/°C<br>10Ω < R ≤ 10MΩ：<br>±200 PPM/°C<br>0402~2512 规格：<br>1Ω ≤ R ≤ 10Ω：<br>±200 PPM/°C<br>10Ω < R ≤ 10MΩ：<br>±100 PPM/°C<br>10MΩ < R ≤ 22MΩ：<br>±200PPM/°C |
| 焊锡性<br>Solderability                          | JIS C 5201 4.17      | 沾助焊剂后浸入锡炉，锡炉温度 245±5°C，时间 3±0.5 秒。<br>Dip the terminal in a flux and then dip into a soldering bath at 245±5°C for 3±0.5sec.  | 最少 95% 面积上锡<br>(Min 95% coverage)   |
| 绝缘电阻<br>Insulation<br>resistance              | JIS C 5201 4.6       | 电阻本体上加载绝缘耐压 60±5 秒后，测量绝缘阻抗。<br>Applied the dielectric withstanding voltage on the center of body for 60±5seconds. Then measure insulation resistance  | >10GΩ   |
| 绝缘耐压<br>Dielectric<br>withstanding<br>voltage | JIS C 5201 4.7       | 电阻本体上加载绝缘耐压 60±5 秒。<br>Applied the dielectric withstanding voltage on the center of body for 60±5seconds.   | 无击穿、飞弧及可见机械性损伤<br>No evidence of flashover, mechanical damage arcing or insulation breakdown  |
| 短时间过负荷<br>Short-time<br>overload              | JIS C 5201 4.13      | 加载 2.5 倍的额定电压，时间 5 秒后测量试验前后的阻值变化率。<br>Applied 2.5 times of rated voltage for 5 second. Measure the variation of resistance.<br><br>$\Delta R\% = \frac{R_2 - R_1}{R_1} * 100 \text{-----} (\%)$ R <sub>1</sub> = 试验前阻值(resistance before test)<br>R <sub>2</sub> = 试验后阻值(resistance after test) | ±(1.0% +0.05Ω) Max  |



## 无铅厚膜贴片电阻承认书-PF 系列

### Approval Specification for Lead Free Thick Film Chip Resistors - Type **PF**

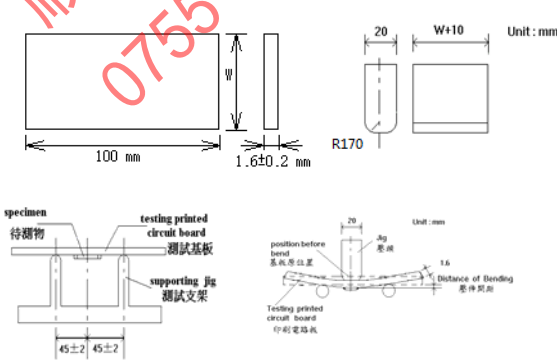
| 内容<br>Item                       | 测试方法<br>Test Methods | 测试条件<br>Test Conditions  | 规格<br>Specification |
|----------------------------------|----------------------|--|---------------------|
| 抗焊锡热<br>Resist to soldering heat | JIS C 5201 4.18      | 沾助焊剂后浸入锡炉，锡炉温度 260±5℃，时间 10±0.5 秒，测量试验前后的阻值变化率。<br>Dip the terminal in a flux and then dip into a soldering bath at 260±5℃ for 10±0.5sec. Measure the variation of resistance.<br><br>$\Delta R\% = \frac{R_2 - R_1}{R_1} * 100 \text{-----} (\%)$ R1 = 试验前阻值(resistance before test)<br>R2 = 试验后阻值(resistance after test)   | ±(1.0%+0.05 Ω) Max  |
| 端子弯曲<br>Terminal bending         | JIS C 5201 4.33      | 电阻焊接在测试板上进行弯折,弯折保持时间 20±1 秒，1206(含) 以下的尺寸弯曲 5 <sup>+0.2</sup> %mm; 1206 以上的尺寸弯曲 2 <sup>+0.2</sup> %mm; 量测试试验前后阻值变化率<br>Specimen shall be mounted on test board, then bend the board and maintained for 20±1s. the distance of bending is 5 <sup>+0.2</sup> %mm for resistors which size no larger than 1206 or 2 <sup>+0.2</sup> %mm which size larger than 1206. Measure the variation of resistance.<br>测试板 (test board) 压头 (jig) <div style="text-align: center;">  </div> $\Delta R\% = \frac{R_2 - R_1}{R_1} * 100 \text{-----} (\%)$ R1 = 试验前阻值(resistance before test)<br>R2 = 试验后阻值(resistance after test) | ±(1.0%+0.05 Ω) Max  |





## 无铅厚膜贴片电阻承认书-PF 系列

### Approval Specification for Lead Free Thick Film Chip Resistors - Type **PF**

| 内容<br>Item                     | 测试方法<br>Test Methods | 测试条件<br>Test Conditions   | 规格<br>Specification |
|--------------------------------|----------------------|---|---------------------|
| 温度循环<br>Temperature<br>Cycling | JIS C 5201 4.19      | 电阻放入温度循环机中，温度 155±2℃ 至 -55±3℃，共 5 个循环。<br>量测试验前后阻值变化率。<br>Put specimen in a chamber which temperature can be changed to 155±2℃ or -55±3℃, repeated 5 times. Measure the variation of resistance.<br>$\Delta R\% = \frac{R_2 - R_1}{R_1} * 100 \text{-----} (\%)$ R1 = 试验前阻值(resistance before test)<br>R2 = 试验后阻值(resistance after test)  | ±(2.0%+0.05 Ω) Max  |
| 耐湿特性<br>Humidity               | JIS C 5201 4.24      | 电阻放入恒温恒湿箱，温度 40±2℃，湿度 90~95 %RH;通电额定电压 1.5 小时，断电 0.5 小时；重复通断电至试验时间 1000 <sup>+48</sup> / <sub>-0</sub> 小时。<br>量测试验前后阻值变化率。<br>Put the specimen in a chamber at 40±2℃ temperature and 90~95% relative humidity, then applied rated voltage for 1.5H and rested for 0.5H repeatedly till total test time is 1000 <sup>+48</sup> / <sub>-0</sub> .. Measure the variation of resistance.<br>$\Delta R\% = \frac{R_2 - R_1}{R_1} * 100 \text{-----} (\%)$ R1 = 试验前阻值(resistance before test)<br>R2 = 试验后阻值(resistance after test) | ±(2.0%+0.05 Ω) Max  |
| 负荷寿命<br>Load life              | JIS C 5201<br>4.25.1 | 电阻放入恒温箱中，温度 70±2℃，ON TIME:1.5H，OFF TIME:0.5H，通电额定电压 1000 <sup>+24</sup> / <sub>-0</sub> 小时，量测试验前后阻值变化率。<br>Put the specimen in a chamber at 70±2℃ temperature, ON TIME:1.5H，OFF TIME:0.5H，and applied rated voltage for 1000 <sup>+24</sup> / <sub>-0</sub> H. Measure the variation of resistance.<br>$\Delta R\% = \frac{R_2 - R_1}{R_1} * 100 \text{-----} (\%)$ R1 = 试验前阻值(resistance before test)<br>R2 = 试验后阻值(resistance after test)   | ±(2.0%+0.05 Ω) Max  |

**Approval Specification for Lead Free Thick Film Chip Resistors - Type PF**

| 内容<br>Item                     | 测试方法<br>Test Methods      | 测试条件<br>Test Conditions  | 规格<br>Specification |
|--------------------------------|---------------------------|--|---------------------|
| 温湿循环<br>Moisture<br>resistance | MIL-STD-202<br>METHOD 106 | 25 ° C~65 ° C,90~100%RH, 2.5 小时 ; 65 ° C<br>90~100%RH, 3小时; 65°C~25°C,80~100%RH,2.5<br>小时,10个循环,试验结束24±4小时后进行测试.<br>25°C~65°C,90~100%RH, 2.5H; 65°C 90~100%RH,<br>3H; 65°C~25°C<br>80~100%RH, 2.5H, 10 cycles, Measurement at<br>24±4 hours after test conclusion.<br><br>$\Delta R\% = \frac{R_2 - R_1}{R_1} * 100 \text{-----} (\%)$ R1 = 试验前阻值(resistance before test)<br>R2 = 试验后阻值(resistance after test) | ±(2.0% +0.05Ω) Max  |

## 10. 包装规格 (Tapping Specification)

## 10.1 卷盘尺寸 (reel dimension)

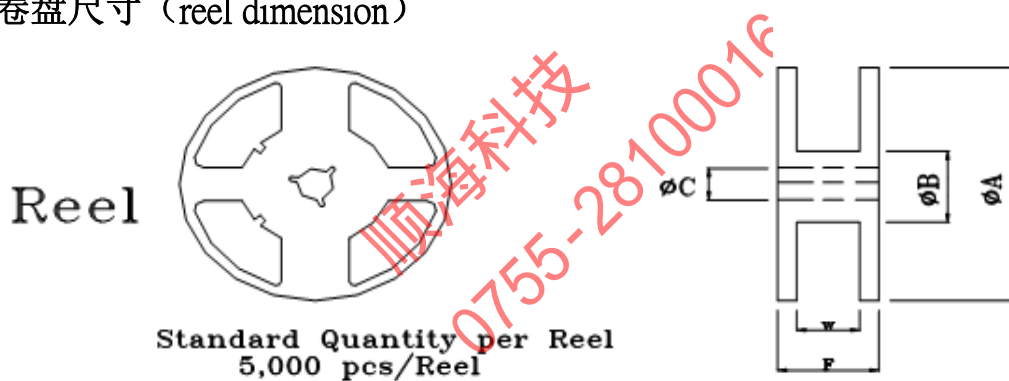

| 尺寸<br>Dimensions |      | A           | B           | C           | F           | W           |
|------------------|------|-------------|-------------|-------------|-------------|-------------|
| PF0201           | mm   | 178±2.0     | 60.0±1.0    | 13.5±0.5    | 11.4±0.1    | 9.00±0.3    |
| PF0402           |      |             |             |             |             |             |
| PF0603           |      |             |             |             |             |             |
| PF0805           | Inch | 7.008±0.079 | 2.362±0.039 | 0.531±0.020 | 0.449±0.039 | 0.354±0.012 |
| PF1206           |      |             |             |             |             |             |
| PF1210           |      |             |             |             |             |             |
| PF2010           | mm   | 178±2.0     | 60.0±1.0    | 13.5±0.5    | 15.4±1.0    | 13.0±0.3    |
| PF2512           | Inch | 7.008±0.079 | 2.362±0.039 | 0.531±0.020 | 0.606±0.039 | 0.512±0.012 |

**Approval Specification for Lead Free Thick Film Chip Resistors - Type PF**

- ※ 备注 (Remark) :
- (1) 0201/0402 每卷 10,000 pcs  
0201/0402 Quantity per Reel 10,000 pcs/Reel
  - (2) 2010/2512 每卷 4,000 pcs  
2010/2512 Quantity per Reel 4,000 pcs/Reel
  - (3) 0603/0805/1206/1210 每卷 5,000pcs  
0603/0805/1206/1210 Quantity per Reel 5,000 pcs/Reel
  - (4) 0402 可依客户要求每卷 20,000pcs  
0402 Quantity per Reel 20,000 pcs/Reel as customer requirement

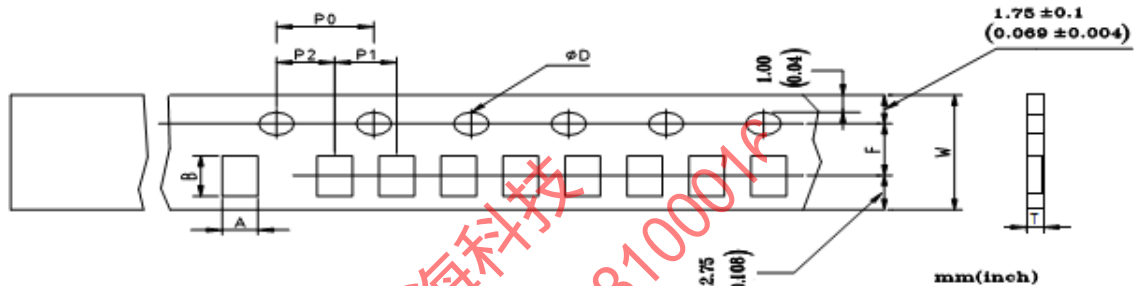
**10.2 包装尺寸 (packing dimension)**

Unit: mm

| Dimensions | A         | B         | D                       | F         | P0        | P1        | P2        | W         | T         |
|------------|-----------|-----------|-------------------------|-----------|-----------|-----------|-----------|-----------|-----------|
| PF0201     | 0.38±0.05 | 0.68±0.05 | 1.50± $\frac{0.1}{0.0}$ | 3.50±0.05 | 4.00±0.10 | 2.00±0.10 | 2.00±0.05 | 8.00±0.20 | 0.42±0.07 |
| PF0402     | 0.65±0.10 | 1.15±0.10 | 1.50± $\frac{0.1}{0.0}$ | 3.50±0.05 | 4.00±0.10 | 2.00±0.10 | 2.00±0.05 | 8.00±0.20 | 0.42±0.07 |
| PF0603     | 1.10±0.10 | 1.90±0.10 | 1.50± $\frac{0.1}{0.0}$ | 3.50±0.05 | 4.00±0.10 | 4.00±0.10 | 2.00±0.05 | 8.00±0.20 | 0.60±0.07 |
| PF0805     | 1.65±0.20 | 2.40±0.20 | 1.50± $\frac{0.1}{0.0}$ | 3.50±0.05 | 4.00±0.10 | 4.00±0.10 | 2.00±0.05 | 8.00±0.20 | 0.75±0.07 |
| PF1206     | 2.00±0.20 | 3.60±0.20 | 1.50± $\frac{0.1}{0.0}$ | 3.50±0.05 | 4.00±0.10 | 4.00±0.10 | 2.00±0.05 | 8.00±0.20 | 0.75±0.07 |
| PF1210     | 2.80±0.20 | 3.50±0.20 | 1.50± $\frac{0.1}{0.0}$ | 3.50±0.05 | 4.00±0.10 | 4.00±0.10 | 2.00±0.05 | 8.00±0.20 | 0.75±0.07 |
| PF2010     | 2.90±0.10 | 5.30±0.10 | 1.50± $\frac{0.1}{0.0}$ | 5.50±0.05 | 4.00±0.10 | 4.00±0.10 | 2.00±0.05 | 12.0±0.10 | 1.0±0.07  |
| PF2512     | 3.40±0.10 | 6.60±0.10 | 1.50± $\frac{0.1}{0.0}$ | 5.50±0.05 | 4.00±0.10 | 4.00±0.10 | 2.00±0.05 | 12.0±0.10 | 1.0±0.07  |

**Approval Specification for Lead Free Thick Film Chip Resistors - Type *PF***
**11. 上胶带剥离力测试 (Peel force of top cover tape)**

上胶带以 200mm/分钟的速度，沿 165~180 度角的方向进行剥离，如下图所示。纸带的剥离力范围为 10g~70g；载带的剥离力范围为 15~80g。

The top cover tape is pulled at a speed of 200mm/min with the angle between the tape during peel and the direction of unreeling maintained at 165 to 180 degree as following picture. The peel force of paper carrier tape shall be 0.1N to 0.7N (10 to 70 g), the peel force of plastic carrier tape shall be 0.15N to 0.8N (15 to 80 g)

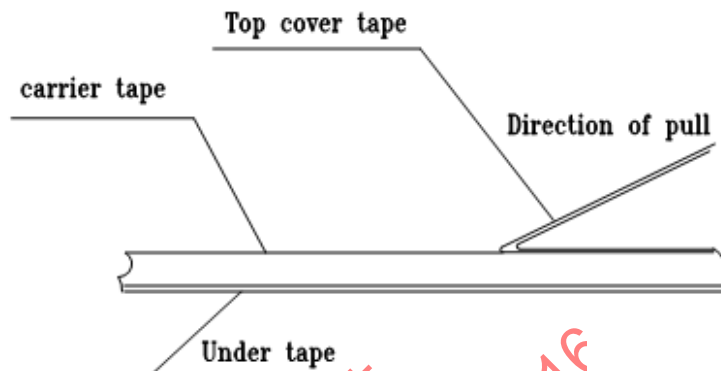
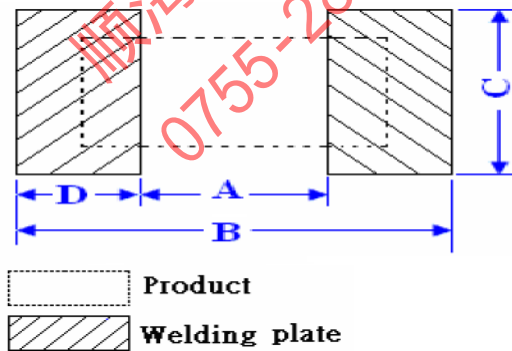
**12. 焊盘尺寸 (Recommended land patterns):**

| Type | Land pattern | Dimensions (mm) |           |           |           |
|------|--------------|-----------------|-----------|-----------|-----------|
|      |              | A               | B         | C         | D         |
|      | PF0201       | 0.25~0.30       | 0.70~0.90 | 0.30~0.40 | 0.23~0.28 |
|      | PF0402       | 0.50~0.60       | 1.40~1.60 | 0.40~0.60 | 0.42~0.52 |
|      | PF0603       | 0.70~0.90       | 2.00~2.20 | 0.80~1.00 | 0.60~0.70 |
|      | PF0805       | 1.00~1.40       | 3.20~3.80 | 0.90~1.40 | 1.10~1.20 |
|      | PF1206       | 2.00~2.40       | 4.40~5.00 | 1.20~1.80 | 1.15~1.35 |
|      | PF1210       | 2.00~2.40       | 4.40~5.00 | 2.30~3.50 | 1.15~1.35 |
|      | PF2010       | 3.30~3.70       | 5.70~6.50 | 2.30~3.50 | 1.20~1.40 |
|      | PF2512       | 3.60~4.00       | 7.60~8.60 | 2.30~3.50 | 2.05~2.25 |



Approval Specification for Lead Free Thick Film Chip Resistors - Type **PF**

13. 焊接 (soldering)

13.1 建议回流焊曲线 (Recommend reflow soldering profile)

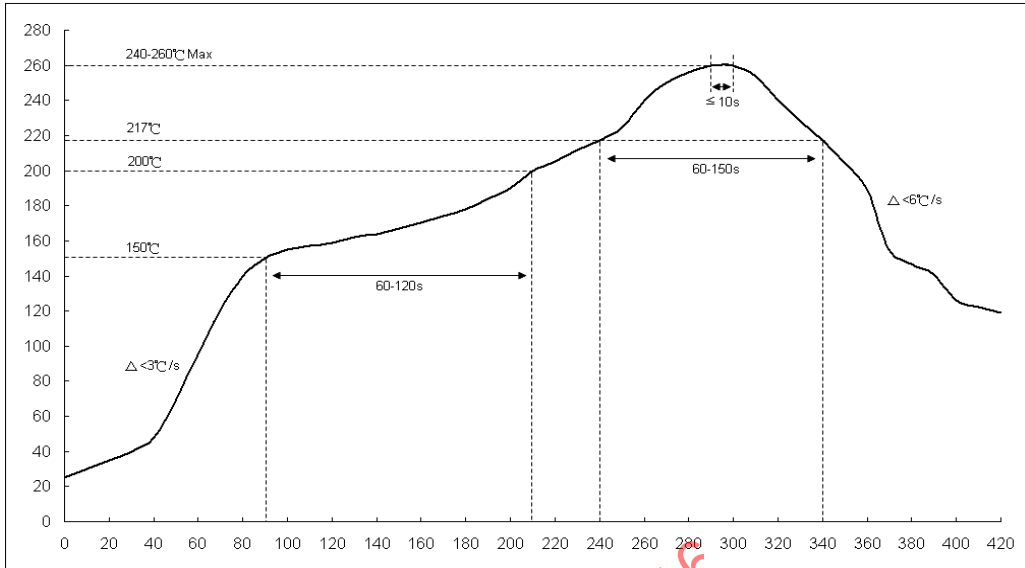

13.2 建议波峰焊曲线 (Recommend wave soldering profile)

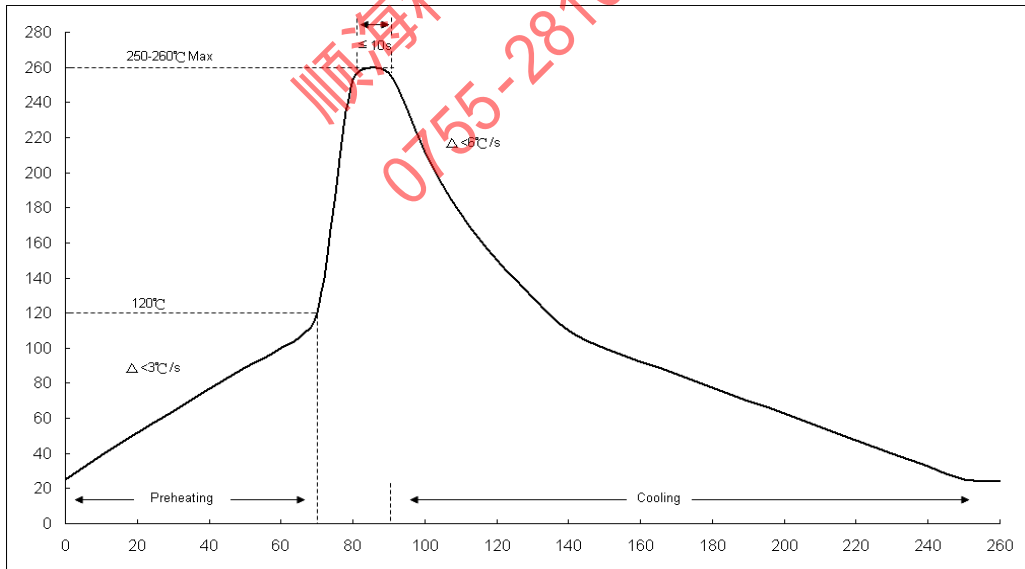

13.3 手工焊温度 (hand soldering temperature)

烙鐵溫度  $350 \pm 10^{\circ}\text{C}$  3 秒之內，避免烙鐵接觸電阻本體

The iron temperature is  $350 \pm 10^{\circ}\text{C}$ , hand soldering time less than 3S. Avoid solder iron tip direct touch the components body