

低阻低 TCR 高功率厚膜贴片电阻承认书-UR 系列

Approval Specification for Low Resistance of Low TCR High Power Thick Film Chip Resistors - Type **UR**

1. 范围 (scope) :

1.1 适用于本公司所生产的无铅、无卤之低阻低 TCR 高功率厚膜贴片电阻 UR 系列

This specification applies to Low resistance of Low TCR High power thick film chip resistors which meet requirements of Pb free and halogen free.

1.2 本公司的无铅产品指的贴片电阻端电极无铅，而存在于电阻层的玻璃中的符合 RoHS 豁免条款。

There no lead exists in terminal of resistor, and lead which exist in glass of resistor layer meets RoHS exemption.

1.3 低温度系数/TCR，高功率

Low temperature coefficient High power



2. 产品料号 (part number) :

0805 1/4W 1% 68mΩ

UR0805F4R068G



<u>UR</u>	<u>0805</u>	<u>F</u>	<u>4</u>	<u>R068</u>	<u>G</u>
类型(Type) UR: 低阻低 TCR 高功率厚 膜贴片电阻 (Low resistance of Low TCR High power thick film chip resistors)	尺寸(Size) 0402 0603 0805 1206 2010 2512	公差 Tolerance F=±1% J=±5%	额定功率 Rated Power 1=1W 2= 3/4W 3=1/2W N= 1/3W 4= 1/4W 8= 1/8W	阻值 Resistance value ±5% : <100mΩ(不含) R050=50mΩ R068=68mΩ ≥ 100mΩ 0R10=100mΩ ±1% : <100mΩ(不含) R050=50 mΩ R068=68mΩ ≥ 100mΩ(含) R100=100mΩ	包装代码 Packing Code G= reel (卷装) V= bulk (散料) S= Double Standard Quantity (两倍卷 盘标准包装量)



低阻低 TCR 高功率厚膜贴片电阻承认书-UR 系列

Approval Specification for Low Resistance of Low TCR High Power Thick Film Chip Resistors - Type UR

3. 电阻本体字码标示(Marking on the Resistor's Body):

<p>※ 0402 因本体太小，本体上无字码标示。 For 0402 size, no marking on the body due to the small size of the resistor</p>		無字碼
<p>※ 0603 尺寸的产品，以三字码标示，第一位码R 表示10^{-3}，后两位表示阻值的有效数字。 For 0603 size, use three digitals to declare resistance. The first letter 'R' denotes 10^{-3}, The other two digitals declare resistance.</p>		068=0R068=0.068 Ω R10=0R100=0.100 Ω
<p>※ 0603 以上尺寸的产品，以四字码标示，第一位码R 表示10^{-3}，后三位表示阻值的有效数字。 The size larger than 0603, use four digitals to declare resistance. The first letter 'R' denotes 10^{-3}, The other three digitals declare resistance.</p>		R068=0R068=0.068 Ω R100=0R100=0.100 Ω

R-value	0805 以上 Code	0603Code	R-value	0805 以上 Code	0603Code	R-value	0805 以上 Code	0603Code
10mΩ	R010	010	100mΩ	R100	R10	360mΩ	R360	R36
15mΩ	R015	015	110mΩ	R110	R11	390mΩ	R390	R39
20mΩ	R020	020	120mΩ	R120	R12	400mΩ	R400	R40
25mΩ	R025	025	130mΩ	R130	R13	430mΩ	R430	R43
30mΩ	R030	030	150mΩ	R150	R15	470mΩ	R470	R47
40mΩ	R040	040	160mΩ	R160	R16	500mΩ	R500	R50
50mΩ	R050	050	180mΩ	R180	R18	510mΩ	R510	R51
56mΩ	R056	056	200mΩ	R200	R20	560mΩ	R560	R56
62mΩ	R062	062	220mΩ	R220	R22	620mΩ	R620	R62
68mΩ	R068	068	240mΩ	R240	R24	680mΩ	R680	R68
75mΩ	R075	075	270mΩ	R270	R27	750mΩ	R750	R75
82mΩ	R082	082	300mΩ	R300	R30	820mΩ	R820	R82
91mΩ	R091	091	330mΩ	R330	R33	910mΩ	R910	R91



低阻低 TCR 高功率厚膜贴片电阻承认书-UR 系列

Approval Specification for Low Resistance of Low TCR High Power Thick Film Chip Resistors - Type **UR**

4.尺寸 (dimension) :

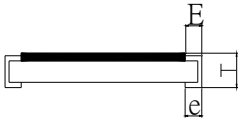
尺寸 dimension					
	单位 (unit) : mm				
型别 (Type)	L	W	T	E	e
UR0402	1.00±0.05	0.50±0.05	0.30±0.05	0.15±0.10	0.20±0.10
UR0603	1.60±0.10	0.80±0.10	0.45±0.10	0.25±0.20	0.30±0.20
UR0805	2.00±0.15	1.25±0.15	0.50±0.10	0.35±0.20	0.40±0.20
UR1206	3.10±0.15	1.60±0.15	0.55±0.10	0.45±0.25	0.40±0.25
UR2010	5.00±0.20	2.50±0.20	0.55±0.15	0.65±0.25	0.50±0.25
UR2512	6.25±0.20	3.10±0.20	0.55±0.15	0.85±0.25	0.95±0.25

5. 功率衰减曲线 (Derating Curve) :

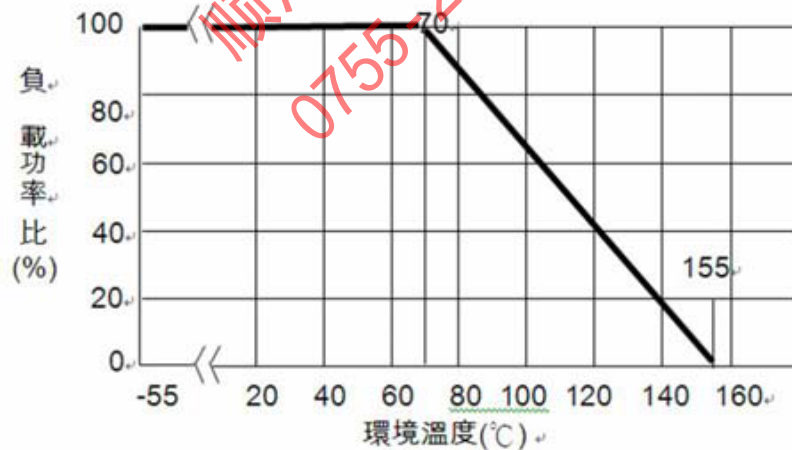

工作温度范围 (Operating Temperature Range) : -55°C~+155°C;

储存条件 (storage condition) : 5~30°C, 30~75%RH.



低阻低 TCR 高功率厚膜贴片电阻承认书-UR 系列

Approval Specification for Low Resistance of Low TCR High Power Thick Film Chip Resistors - Type **UR**

6.电阻结构（Construction）：

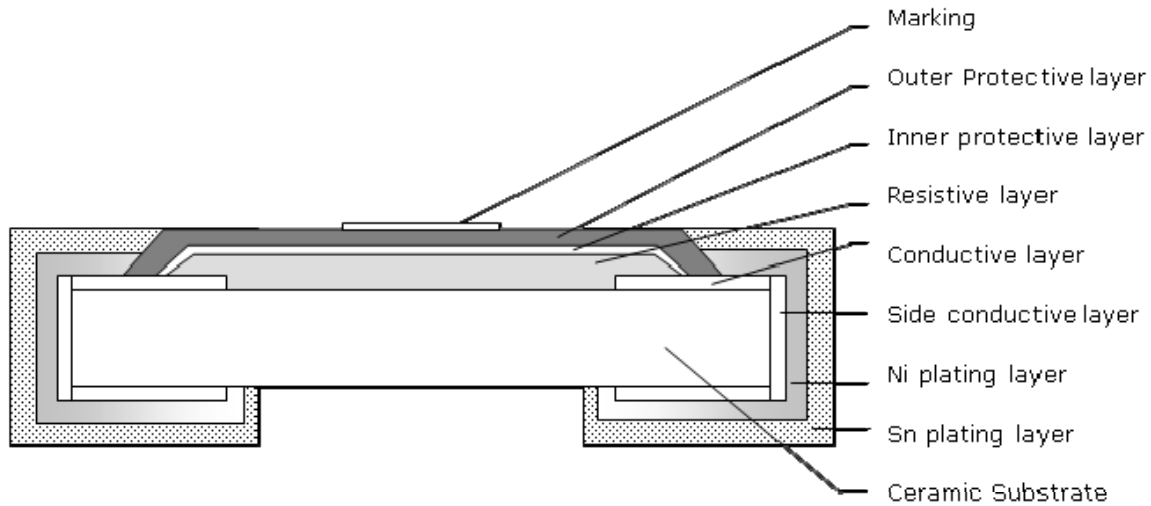

No.	结构 construction	主要材料 Major material
1	陶瓷基板 Ceramic substrate	三氧化二铝 Al ₂ O ₃
2	银电极 Conductive layer	银 Ag
3	侧电极 Side conductive layer	镍铬合金 NiCr
4	阻体层 Resistive layer	氧化钌+玻璃 RuO ₂ + glass
5	内保护层 Inner protective layer	玻璃 Glass
6	外保护层 Outer Protective layer	环氧树脂 Epoxy
7	文字 Marking	环氧树脂 Epoxy
8	镍电极 Ni plating layer	镍 Ni
9	锡电极 Sn plating layer	雾锡 Matte Tin



低阻低 TCR 高功率厚膜贴片电阻承认书-UR 系列

Approval Specification for Low Resistance of Low TCR High Power Thick Film Chip Resistors - Type UR

7. 阻值范围 (resistance range) :

型别 Type	阻值范围 Resistance Range	溫度係數 T.C.R (PPM/°C)	公差 Tolerance
UR0402	0.024Ω~0.027Ω	±500	±1%(F) ±5%(J)
	0.030Ω~0.910Ω	±100	
UR0603	0.010Ω~0.027Ω	±300	
	0.030Ω~0.043Ω	±200	
	0.047Ω~0.910Ω	±100	
UR0805	0.010Ω~0.043Ω	±250	
	0.047Ω~0.910Ω	±100	
UR1206	0.010Ω~0.043Ω	±200	
	0.047Ω~0.910Ω	±100	
UR2010	0.010Ω~0.030Ω	±250	
	0.033Ω~0.910Ω	±100	
UR2512	0.010Ω~0.030Ω	±250	
	0.033Ω~0.910Ω	±100	

8. 电气特性(Electrical Characteristics):

型别 Type	UR0402	UR0603	UR0805	UR1206	UR2010	UR2512
额定功率 Rated power	1/8W	1/4W	1/4W	1/3W	1/2W	1W
最大工作電流 Max Working Current	2.28A	5.00A	5.00A	5.77A	7.07A	10.00A
最大過負荷電流 Max Overload Current	5.71A	12.50A	12.50A	14.43A	17.68A	25.00A
绝缘耐压 Dielectric Withstanding Voltage	150V	220V	430V	430V	570V	710V

备注 (remark) :

※ 额定电流计算公式 (The rated current is calculated by the following formula) :

$$I = \sqrt{P/R}$$

I : 额定电流 (Rated current) (A)

P : 额定功率 (Rated Power) (W)

R : 电阻阻值 (Resistance) (ohm)

※ 如果计算出的电流超过此型别的最大工作电流, 则此型别的最大工作电流为此电阻的额定电流。

In case the value calculated by the formula exceed the maximum working current as above table 8, the maximum working current shall be regarded as rated current.



低阻低 TCR 高功率厚膜贴片电阻承认书-UR 系列

Approval Specification for Low Resistance of Low TCR High Power Thick Film Chip Resistors - Type UR

9.性能信赖性测试 (Performance Reliability Test Methods)

内容 Item	测试方法 Test Methods	测试条件 Test Conditions	规格 Specification
温度系数 Temperature Coefficient	JIS C 5201 4.8	$TCR = (R - R_0) / (t - t_0) R_0 \times 10^6$ (ppm) R ₀ 电阻在室温下的阻值(resistance at room temperature) R 电阻在 125°C 或 -55°C 下的阻值(resistance at 125°C or -55°C) t ₀ 室温(room temperature) t 测试温度 (test temperature 125°C or -55°C)	参照 7 项对应表
焊锡性 Solderability	JIS C 5201 4.17	沾助焊剂后浸入锡炉，锡炉温度 245±5°C，时间 3±0.5 秒。 Dip the terminal in a flux and then dip into a soldering bath at 245±5°C for 3±0.5sec.	最少 95% 面积上锡 (Min 95% coverage)
绝缘电阻 Insulation resistance	JIS C 5201 4.6	电阻本体上加载绝缘耐压 60±5 秒后，测量绝缘阻抗。 Applied the dielectric withstanding voltage on the center of body for 60±5seconds. Then measure insulation resistance.	>10G Ω
绝缘耐压 Dielectric withstanding voltage	JIS C 5201 4.7	电阻本体上加载绝缘耐压 60±5 秒。 Applied the dielectric withstanding voltage on the center of body for 60±5seconds.	无击穿、飞弧及可见机械性损伤 No evidence of flashover, mechanical damage arcing or insulation breakdown
短时间过负荷 Short-time overload	JIS C 5201 4.13	加载 2.5 倍的额定电压，时间 5 秒后测量试验前后的阻值变化率。 Applied 2.5 times of rated voltage for 5 second. Measure the variation of resistance. $\Delta R\% = \frac{R_2 - R_1}{R_1} * 100 \text{-----} (\%)$ R1 = 试验前阻值(resistance before test) R2 = 试验后阻值(resistance after test)	±(2.0%+0.001 Ω) Max
抗焊锡热 Resist to soldering heat	JIS C 5201 4.18	沾助焊剂后浸入锡炉，锡炉温度 260±5°C，时间 10±0.5 秒，测量试验前后的阻值变化率。 Dip the terminal in a flux and then dip into a soldering bath at 260±5°C for 10±0.5sec. Measure the variation of resistance. $\Delta R\% = \frac{R_2 - R_1}{R_1} * 100 \text{-----} (\%)$ R1 = 试验前阻值(resistance before test) R2 = 试验后阻值(resistance after test)	±(1.0%+0.001 Ω) Max



低阻低 TCR 高功率厚膜贴片电阻承认书-UR 系列

Approval Specification for Low Resistance of Low TCR High Power Thick Film Chip Resistors - Type UR

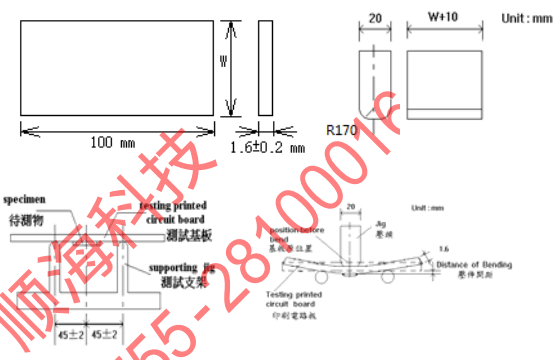
内容 Item	测试方法 Test Methods	测试条件 Test Conditions	规格 Specification
端子弯曲 Terminal bending	JIS C 5201 4.33	<p>电阻焊接在测试板上进行弯折,弯折保持时间 20±1 秒, 1206(含) 以下的尺寸弯曲 5^{+0.2}%mm; 1206 以上的尺寸弯曲 2^{+0.2}%mm; 量测试验前后阻值变化率</p> <p>Specimen shall be mounted on test board, then bend the board and maintained for 20±1s. the distance of bending is 5^{+0.2}%mm for resistors which size no larger than 1206 or 2^{+0.2}%mm which size larger than 1206. Measure the variation of resistance.</p> <p style="text-align: center;">测试板 (test board) 压头 (jig)</p> <div style="text-align: center;">  </div> $\Delta R\% = \frac{R_2 - R_1}{R_1} * 100 \text{-----} (\%)$ <p>R1 = 试验前阻值(resistance before test) R2 = 试验后阻值(resistance after test)</p>	±(2.0%+0.001Ω) Max
温度循环 Temperature Cycling	JIS C 5201 4.19	<p>电阻放入温度循环机中, 温度 155±2℃ 至 -55±3℃, 共 5 个循环。 量测试验前后阻值变化率。</p> <p>Put specimen in a chamber which temperature can be changed to 155±2℃ or -55±3℃, repeated 5 times. Measure the variation of resistance.</p> $\Delta R\% = \frac{R_2 - R_1}{R_1} * 100 \text{-----} (\%)$ <p>R1 = 试验前阻值(resistance before test) R2 = 试验后阻值(resistance after test)</p>	±(2.0%+0.001Ω) Max

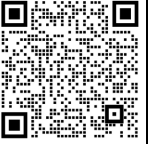

低阻低 TCR 高功率厚膜贴片电阻承认书-UR 系列

Approval Specification for Low Resistance of Low TCR High Power Thick Film Chip Resistors - Type UR

内容 Item	测试方法 Test Methods	测试条件 Test Conditions	规格 Specification
耐湿特性 Humidity	JIS C 5201 4.24	<p>电阻放入恒温恒湿箱，温度 40±2℃，湿度 90~95 %RH;通电额定电压 1.5 小时，断电 0.5 小时；重复通断电至试验时间 1000⁺⁴⁸/₀ 小时。量测试验前后阻值变化率。</p> <p>Put the specimen in a chamber at 40±2℃ temperature and 90~95% relative humidity, then applied rated voltage for 1.5H and rested for 0.5H repeatedly till total test time is 1000⁺⁴⁸/₀.. Measure the variation of resistance.</p> $\Delta R\% = \frac{R_2 - R_1}{R_1} * 100 \text{-----} (\%)$ <p>R1 = 试验前阻值(resistance before test) R2 = 试验后阻值(resistance after test)</p>	±(2.0%+0.001 Ω) Max
负荷寿命 Load life	JIS C 5201 4.25.1	<p>电阻放入恒温箱中，温度 70±2℃，ON TIME:1.5H，OFF TIME:0.5H，通电额定电压 1000⁺²⁴/₀小时，量测试验前后阻值变化率。</p> <p>Put the specimen in a chamber at 70±2℃ temperature, ON TIME:1.5H，OFF TIME:0.5H，and applied rated voltage for 1000⁺²⁴/₀H. Measure the variation of resistance.</p> $\Delta R\% = \frac{R_2 - R_1}{R_1} * 100 \text{-----} (\%)$ <p>R1 = 试验前阻值(resistance before test) R2 = 试验后阻值(resistance after test)</p>	±(3.0%+0.001 Ω) Max
温湿循环 Moisture resistance	MIL-STD-202 METHOD 106	<p>25 ° C~65 ° C,90~100%RH, 2.5 小时； 65 ° C 90~100%RH, 3小时; 65°C~25°C,80~100%RH,2.5 小时,10个循环,试验结束24±4小时后进行测试。</p> <p>25 ° C~65 ° C,90~100%RH, 2.5H; 65 ° C 90~100%RH, 3H; 65°C~25°C 80~100%RH, 2.5H, 10 cycles, Measurement at 24±4 hours after test conclusion.</p> $\Delta R\% = \frac{R_2 - R_1}{R_1} * 100 \text{-----} (\%)$ <p>R1 = 试验前阻值(resistance before test) R2 = 试验后阻值(resistance after test)</p>	±(2.0% +0.001 Ω) Max



低阻低 TCR 高功率厚膜贴片电阻承认书-UR 系列

Approval Specification for Low Resistance of Low TCR High Power Thick Film Chip Resistors - Type UR

内容 Item	测试方法 Test Methods	测试条件 Test Conditions	规格 Specification
高温储存 High Temperature Exposure(Storage)	MIL-STD-202 METHOD 108	155℃下放置 1000h,不加载功率，试验结束 24±4 小时后进行测试。 1000 hrs. @ T=155℃. Unpowered. Measurement at 24±4 hours after test conclusion $\Delta R\% = \frac{R_2 - R_1}{R_1} * 100 \text{-----} (\%)$ R1 = 试验前阻值(resistance before test) R2 = 试验后阻值(resistance after test)	±(1.0% +0.001Ω) Max

10. 包装规格 (Tapping Specification)

10.1 卷盘尺寸 (reel dimension)

尺寸 Dimensions		A	B	C	F	W
UR0402	mm	178±2.0	60.0±1.0	13.5±0.5	11.4±0.1	9.00±0.3
UR0603	Inch	7.008±0.079	2.362±0.039	0.531±0.020	0.449±0.039	0.354±0.012
UR0805						
UR1206						
UR2010	mm	178±2.0	60.0±1.0	13.5±0.5	15.4±1.0	13.0±0.3
UR2512	Inch	7.008±0.079	2.362±0.039	0.531±0.020	0.606±0.039	0.512±0.012

- ※ 备注 (Remark) :
- (1) 0402 每卷 10,000 pcs
0402 Quantity per Reel 10,000 pcs/Reel
 - (2) 2010/2512 每卷 4,000 pcs
2010/2512 Quantity per Reel 4,000 pcs/Reel
 - (3) 0603/0805/1206/每卷 5,000pcs
0603/0805/1206/ Quantity per Reel 5,000 pcs/Reel

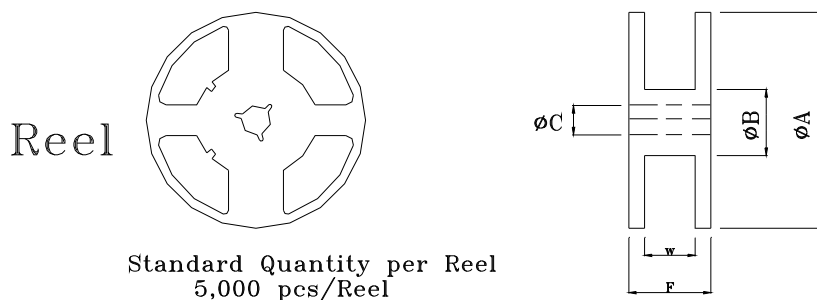



低阻低 TCR 高功率厚膜贴片电阻承认书-UR 系列

Approval Specification for Low Resistance of Low TCR High Power Thick Film Chip Resistors - Type **UR**

10.2 包装尺寸 (packing dimension)

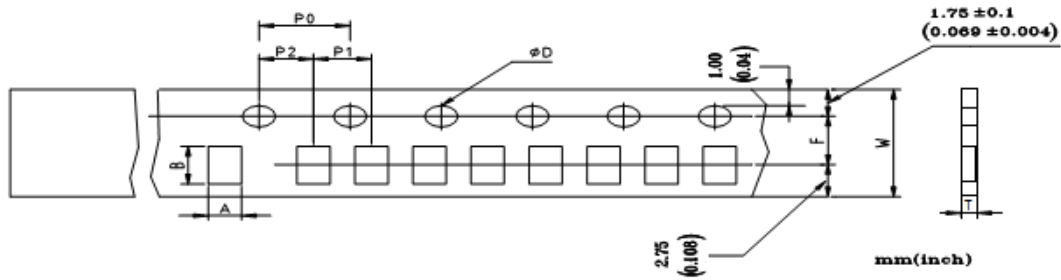

Unit: mm

Dimensions	A	B	D	F	P0	P1	P2	W	T
UR0402	0.65±0.10	1.15±0.10	1.50± $\frac{0.1}{0.0}$	3.50±0.05	4.00±0.10	2.00±0.10	2.00±0.05	8.00±0.20	0.42±0.07
UR0603	1.10±0.10	1.90±0.10	1.50± $\frac{0.1}{0.0}$	3.50±0.05	4.00±0.10	4.00±0.10	2.00±0.05	8.00±0.20	0.60±0.07
UR0805	1.65±0.20	2.40±0.20	1.50± $\frac{0.1}{0.0}$	3.50±0.05	4.00±0.10	4.00±0.10	2.00±0.05	8.00±0.20	0.75±0.07
UR1206	2.00±0.20	3.60±0.20	1.50± $\frac{0.1}{0.0}$	3.50±0.05	4.00±0.10	4.00±0.10	2.00±0.05	8.00±0.20	0.75±0.07
UR2010	2.90±0.10	5.30±0.10	1.50± $\frac{0.1}{0.0}$	5.50±0.05	4.00±0.10	4.00±0.10	2.00±0.05	12.0±0.10	1.0±0.07
UR2512	3.40±0.10	6.60±0.10	1.50± $\frac{0.1}{0.0}$	5.50±0.05	4.00±0.10	4.00±0.10	2.00±0.05	12.0±0.10	1.0±0.07



低阻低 TCR 高功率厚膜贴片电阻承认书-UR 系列

Approval Specification for Low Resistance of Low TCR High Power Thick Film Chip Resistors - Type **UR**

12. 上胶带剥离力测试 (Peel force of top cover tape)

上胶带以 200mm/分钟的速度，沿 165~180 度角的方向进行剥离，如下图所示。纸带的剥离力范围为 10g~70g；载带的剥离力范围为 15~80g。

The top cover tape is pulled at a speed of 200 mm/min with the angle between the tape during peel and the direction of unreeling maintained at 165 to 180 degree as following picture. The peel force of paper carrier tape shall be 0.1N to 0.7N (10 to 70 g), the peel force of plastic carrier tape shall be **0.15N to 0.80N (15 to 80 g)**

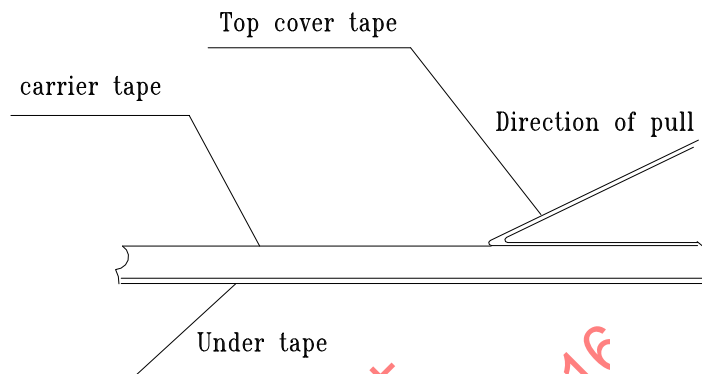

13. 焊盘尺寸 (Recommended land patterns):

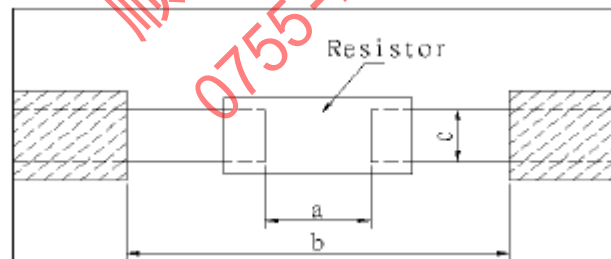

Type	Land pattern	Dimensions (mm)		
		a	b	c
	UR0402	0.5~0.6	1.4~1.6	0.4~0.6
	UR0603	0.7~0.9	2.0~2.2	0.8~1.0
	UR0805	1.0~1.4	3.2~3.8	0.9~1.4
	UR1206	2.0~2.4	4.4~5.0	1.2~1.8
	UR2010	3.3~3.7	5.7~6.5	2.3~3.5
	UR2512	3.6~4.0	7.6~8.6	2.3~3.5



低阻低 TCR 高功率厚膜贴片电阻承认书-UR 系列

Approval Specification for Low Resistance of Low TCR High Power Thick Film Chip Resistors - Type **UR**

14. 焊接 (soldering)

14.1 建议回流焊曲线 (Recommend reflow soldering profile)

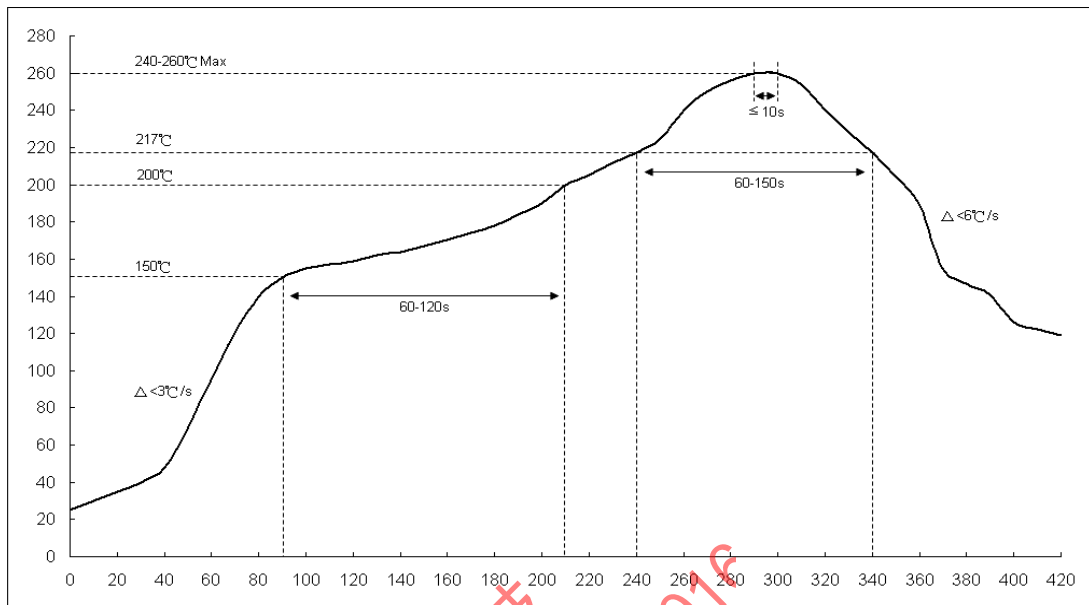

14.2 建议波峰焊曲线 (Recommend wave soldering profile)

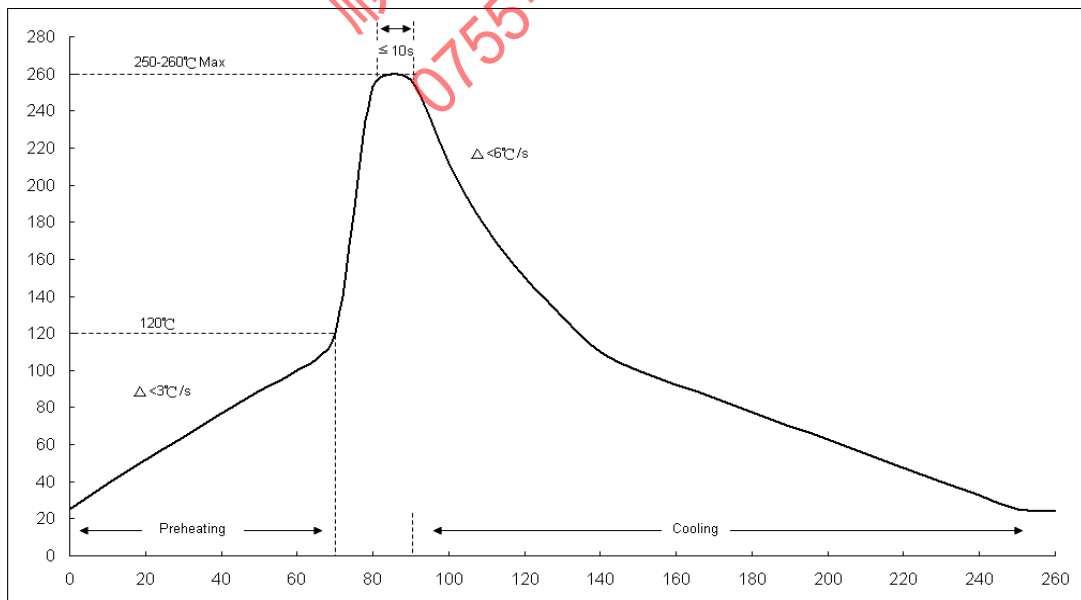

14.3 手工焊温度 (hand soldering temperature)

烙鐵溫度 $350 \pm 10^\circ\text{C}$ 3 秒之內，避免烙鐵接觸電阻本體

The iron temperature is $350 \pm 10^\circ\text{C}$, hand soldering time less than 3S. Avoid solder iron tip direct touch the components body.